

User Manual

Astraada HMI Panel PC

AS47CN08, AS47CN10, AS47CN15, AS47CN17, AS47CN21



Warning!

This equipment generates, uses and can radiate radio frequency energy and if not installed and used in accordance with the instructions manual, it may cause interference to radio communications. It has been tested and found to comply with the limits for a Class A computing device pursuant to FCC Rules, which are designed to provide reasonable protection against such interference when operated in a commercial environment. Operation of this equipment in a residential area is likely to cause interference in which case the user at his own expense will be required to take whatever measures may be required to correct the interference.

Electric Shock Hazard – Do not operate the machine with its back cover removed. There are dangerous high voltages inside.

Avertissement!

Cet équipement génère, utilise et peut émettre une énergie de radiofréquence et s'il n'est pas installé et utilisé conformément au manuel d'instructions, il peut provoquer des interférences dans les communications radio. Il a été testé et approuvé conforme aux limites pour un dispositif de classe A et selon les règles de la FCC, qui sont conçues pour fournir une protection raisonnable contre de telles interférences dans un environnement commercial. Le fonctionnement de cet équipement dans une zone résidentielle est susceptible de provoquer des interférences, dans ce cas l'utilisateur, à ses propres frais, devra faire le nécessaire pour prendre toutes les mesures requises pour corriger le problème.

Risque de choc électrique - Ne pas faire fonctionner la machine avec son capot arrière enlevé. Des tensions dangereuses sont élevées à l'intérieur.

Caution

**Risk of explosion if the battery is replaced with an incorrect type.
Batteries should be recycled where possible. Disposal of used batteries must be in accordance with local environmental regulations.**

Precaution

**Risque d'explosion si la pile usagée est remplacée par une pile de type incorrect.
Les piles usagée doivent être recyclées dans la mesure du possible. La mise au rebut des piles usagées doit respecter les réglementations locales en vigueur en matière de protection de l'environnement.**

Packing List

Accessories (as ticked) included in this package are:
<input type="checkbox"/> Adaptor
<input type="checkbox"/> Driver & manual CD disc
<input type="checkbox"/> Other. _____ (please specify)

Safety Precautions

Follow the messages below to prevent your systems from damage:

- ◆ Avoid your system from static electricity on all occasions.
- ◆ Prevent electric shock. Don't touch any components of this card when the card is power-on. Always disconnect power when the system is not in use.
- ◆ Disconnect power when you change any hardware devices. For instance, when you connect a jumper or install any cards, a surge of power may damage the electronic components or the whole system.

Consignes de sécurité

Suivez les messages ci-dessous pour éviter que vos systèmes contre les dommages:

- ◆ Éviter votre système contre l'électricité statique sur toutes les occasions.
- ◆ Évitez les chocs électriques. Ne pas toucher les composants de cette carte lorsque la carte est sous tension. Toujours débrancher lorsque le système n'est pas en cours d'utilisation.
- ◆ Couper l'alimentation électrique lorsque vous changez tous les périphériques matériels. Par exemple, lorsque vous connectez un cavalier ou d'installer des cartes, une forte augmentation de la puissance peut endommager les composants électroniques ou l'ensemble du système.

Table of Contents

Revision History.....	1
Warning!/Avertissement!.....	2
Caution/Precaution.....	3
Packing List.....	4
Safety Precautions/Consignes de sécurité.....	5

Chapter 1 Getting Started

1.1 Features.....	8
1.2 Specifications.....	8
1.3 Dimensions.....	11
1.4 Brief Description of AS47CN.....	17
1.5 Installation of HDD – 7”/8”.....	22
1.6 Installation of HDD – 10.1”/15.6”/18.5”.....	24
1.7 Installation of HDD – 12.1”/15”/17”/21.5”.....	25
1.8 VESA Mounting.....	27
1.9 Panel Mounting.....	27

Chapter 2 Hardware

2.1 Motherboard Introduction.....	28
2.2 Specifications.....	28
2.3 Jumpers and Connectors Location.....	32
2.4 Jumpers Setting and Connectors.....	33

Chapter 3 BIOS Setup

3.1 Operations after POST Screen.....	61
3.2 BIOS Setup Utility.....	61
3.3 Main Settings.....	62
3.4 Advanced Settings.....	63
3.5 Chipset Settings.....	71
3.6 Security Settings.....	73
3.7 Boot Settings.....	74
3.8 Save & Exit Settings.....	75

Chapter 4 Installation of Drivers

4.1 Intel (R) Atom™ SoC Chipset	78
---------------------------------------	----

4.2 Intel (R) VGA Chipset.....	81
4.3 Intel (R) LAN Driver.....	85
4.4 Realtek ALC662 HD Audio Driver Installation.....	88
4.5 USB 3.0 Driver.....	90

Chapter 5 **Touch Screen Installation**

5.1 Windows XP/2003/Vista/WIN7 Universal Driver Installation for PenMount 6000 Series.....	93
5.2 Software Functions.....	103

Figures

Figure 1.1: Dimensions of AS47CN07.....	11
Figure 1.2: Dimensions of AS47CN08.....	11
Figure 1.3: Dimensions of AS47CN10.....	12
Figure 1.4: Dimensions of AS47CN12.....	12
Figure 1.5: Dimensions of AS47CN15.....	13
Figure 1.6: Dimensions of AS47CN16(Resistive Touch).....	13
Figure 1.7: Dimensions of AS47CN16(Projected Capacitive Touch)...	14
Figure 1.8: Dimensions of AS47CN17.....	14
Figure 1.9: Dimensions of AS47CN18.....	15
Figure 1.10: Dimensions of AS47CN21(Resistive Touch).....	15
Figure 1.11: Dimensions of AS47CN21(Projected Capacitive Touch).16	
Figure 1.12: Front View of AS47CN Series.....	17
Figure 1.13: Rear View of AS47CN07/08.....	18
Figure 1.14: Rear View of AS47CN10.....	18
Figure 1.15: Rear View of AS47CN12.....	19
Figure 1.16: Rear View of AS47CN15.....	19
Figure 1.17: Rear View of AS47CN16.....	20
Figure 1.18: Rear View of AS47CN17.....	20
Figure 1.19: Rear View of AS47CN18.....	21
Figure 1.20: Rear View of AS47CN21.....	21
Figure 1.21: AS47CN Series VESA Mounting.....	27
Figure 1.22: AS47CN Series Panel Mounting.....	27
Figure 2.1: Motherboard Dimensions.....	31
Figure 2.2: Jumpers and Connectors Location-Board Top.....	32
Figure 2.3: Jumpers and Connectors Location-Board Bottom.....	32

Chapter 1

Getting Started

1.1 Features

- 7"/8"/10.1"/12.1"/15"/15.6"/17"/18.5"/21.5" Industrial Compact Size Panel PC
- Flat front panel touch screen
- Fanless design
- Intel Bay Trail N2930(1.83GHz) CPU built-in/E3845(1.91GHz) for option
- Onboard 2GB DDR 3L 1600 MHz/4GB(option)
- 9~36VDC wide-ranging power input
- IP65 compliant front panel
- Optional projected capacitive touchscreen support 7H anti-scratch surface

1.2 Specifications

	AS47CN Series
System	
CPU	Onboard Intel Bay Trail N2930(1.83GHz)/E3845(1.91GHz) for option
Chipset	SoC
Memory	Onboard 2GB DDR 3L 1600 MHz/4GB(option)
IO Port	
USB	1 x USB 2.0 type A 1 x USB 3.0 type A
Serial/Parallel	1 x RS-232 DB-9(COM2) 1 x DB-9 RS-232/422/485 (Default RS-232)(COM1)
Audio	1 x Audio Line Out
LAN	2 x GbE LAN RJ-45
Power	1 x 3-pin DC Power input terminal 1 x 2-pin connector for power on/off button
Option (Not available for AS47CN07 and AS47CN08)	2 x RS-232 DB-9 + 1 x Mini-PCIe slot via TB-528C2ME1 2 x CAN bus via TB-528CAN2 2 x USB 2.0 type A Via TB-528U2 2 x USB 2.0 type A + 1 x Mini-PCIe slot + 1xRS-232 DB-9 via TB-528C1U2P1 (TB-528C1U2 for AS47CN10)

Storage Space	
Storage	1 x SD card slot, up to 32GB 1 x MO-297 SATA SSD bay (Easy Accessible) (for 7"/8") 1 x 2.5" SATA HDD bay for SATA HDD (Easy Accessible)
Expansion	
Expansion Slot	1 x Internal Mini-PCIe slot full size
Touch Screen – Resistive Touch Window Type	
TS Control IC	PenMount 6000 on Board
Interface	USB
Light Transmission(%)	Over 80%
Touch Screen – Projected Capacitive Type	
TS Control IC	Chip on tail
Interface	USB
Light Transmission(%)	Over 90%
Power	
Power Input	9~36V/DC
Mechanical	
Construction	RAL 9007
IP Rating	IP65 compliant front panel
Environmental	
Operating temperature(°C)	0~50°C
Storage temperature(°C)	-20~60°C
Storage humidity	10 to 90% @ 40°C, non- condensing
Certification	CE / FCC Class A
Operating System Support	
OS Support	Windows Embedded Compact 7, Windows 7, Windows Embedded Standard 7, Windows 8, Windows Embedded 8 Standard, Windows 8.1 Windows Embedded 8.1 Industry

	AS47CN07	AS47CN08	AS47CN10	AS47CN12	AS47CN15
Display					
Display Type	7" TFT LCD	8" TFT LCD	10.1" TFT LCD	12.1" TFT LCD	15" TFT LCD
Max. Resolution	800 x 480	800 x 600	1280 x 800	800 x 600	1024 x 768
Max. Color	262K	16.2M	16.2M	16.2M	16.2M
Luminance(cd/m ²)	350	350	350	450	300
Contrast Ratio	400 : 1	500 : 1	800 : 1	800 : 1	800 : 1
Viewing angle	140(H)/110(V)	140(H)/125(V)	160(H)/160(V)	160(H)/140(V)	170(H)/170(V)
Backlight Lifetime	40,000 hrs	40,000 hrs	40,000 hrs	50,000 hrs	50,000 hrs
Mounting	VESA Mount 75 x 75		VESA Mount 100 x 100		
Dimensions(mm)	202 x 149 x 40	231 x 176 x 50	285 x 189 x 49	319 x 243 x 52	410 x 310 x 55

	AS47CN16	AS47CN17	AS47CN18	AS47CN21
Display				
Display Type	15.6" TFT LCD	17" TFT LCD	18.5" TFT LCD	21.5" TFT LCD
Max. Resolution	1366 x 768	1280 x 1024	1366 x 768	1920 x 1080
Max. Color	16.7M	16.7M	16.7M	16.7M
Luminance (cd/m ²)	300	350	300	250
Contrast Ratio	500 : 1	1000 : 1	1000 : 1	3000 : 1
Viewing angle	160 (H)/ 160 (V)	170 (H)/ 160 (V)	170 (H)/ 160 (V)	178 (H)/ 178 (V)
Backlight Lifetime	50,000 hrs	30,000 hrs	50,000 hrs	30,000 hrs
Mounting	VESA Mount 100 x 100			
Dimensions(mm)	412 x 277.5 x 60.4	439 x 348 x 64.8	499.6 x 314.6 x 60	557 x 362 x 64.8

1.3 Dimensions

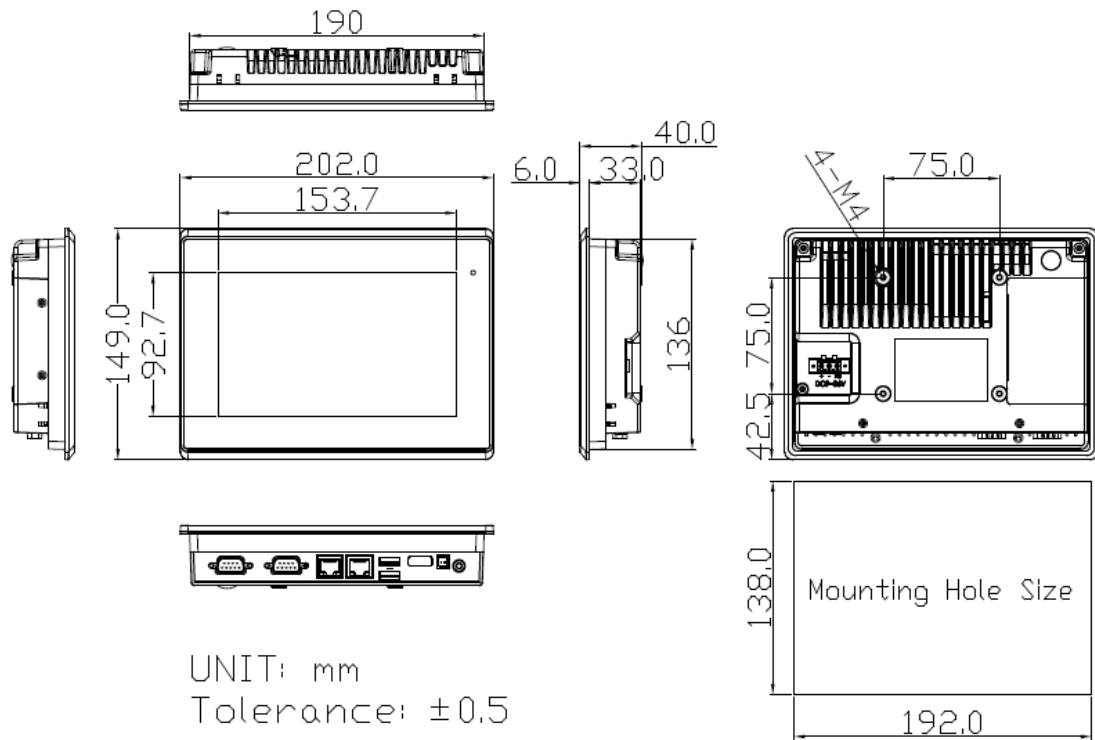

Figure 1.1: Dimensions of AS47CN07

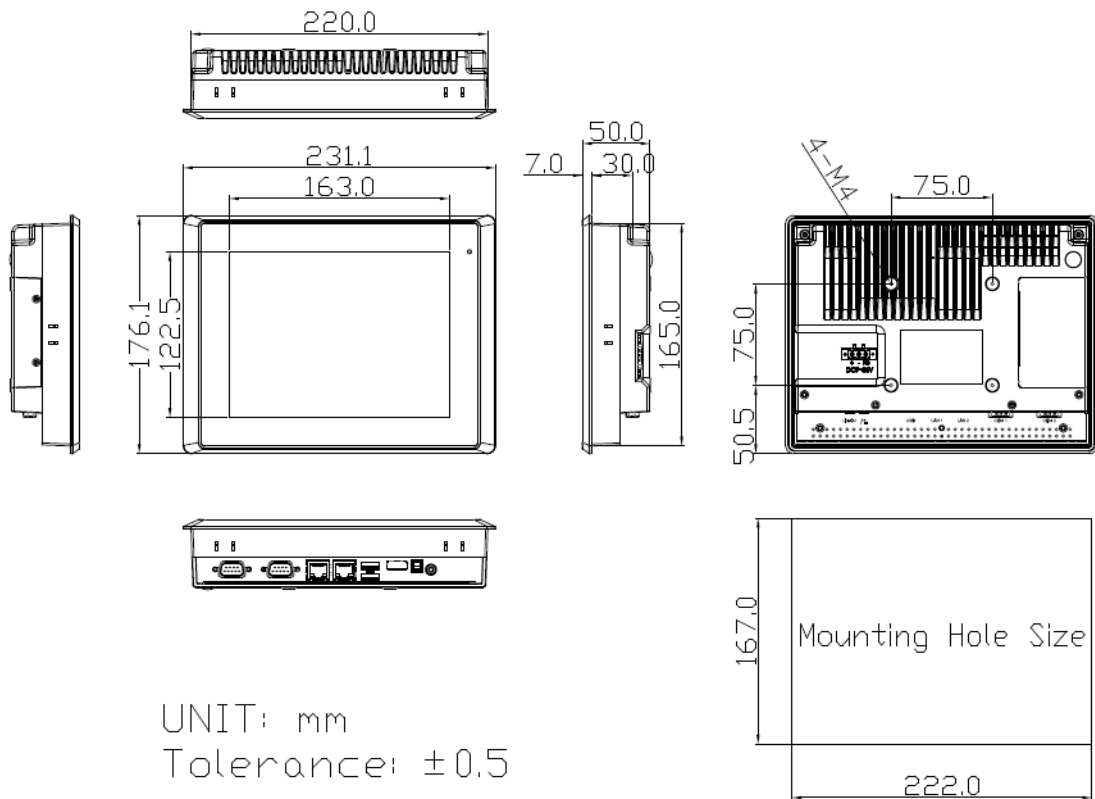

Figure 1.2: Dimensions of AS47CN08

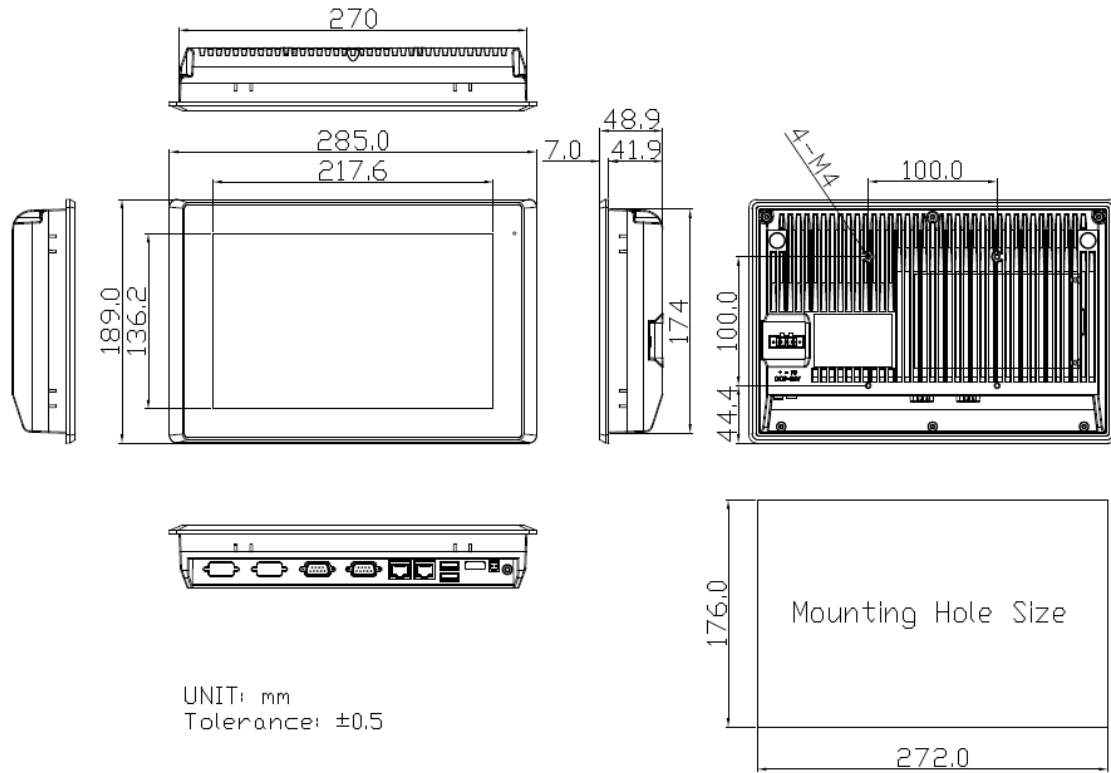

Figure 1.3: Dimensions of AS47CN10

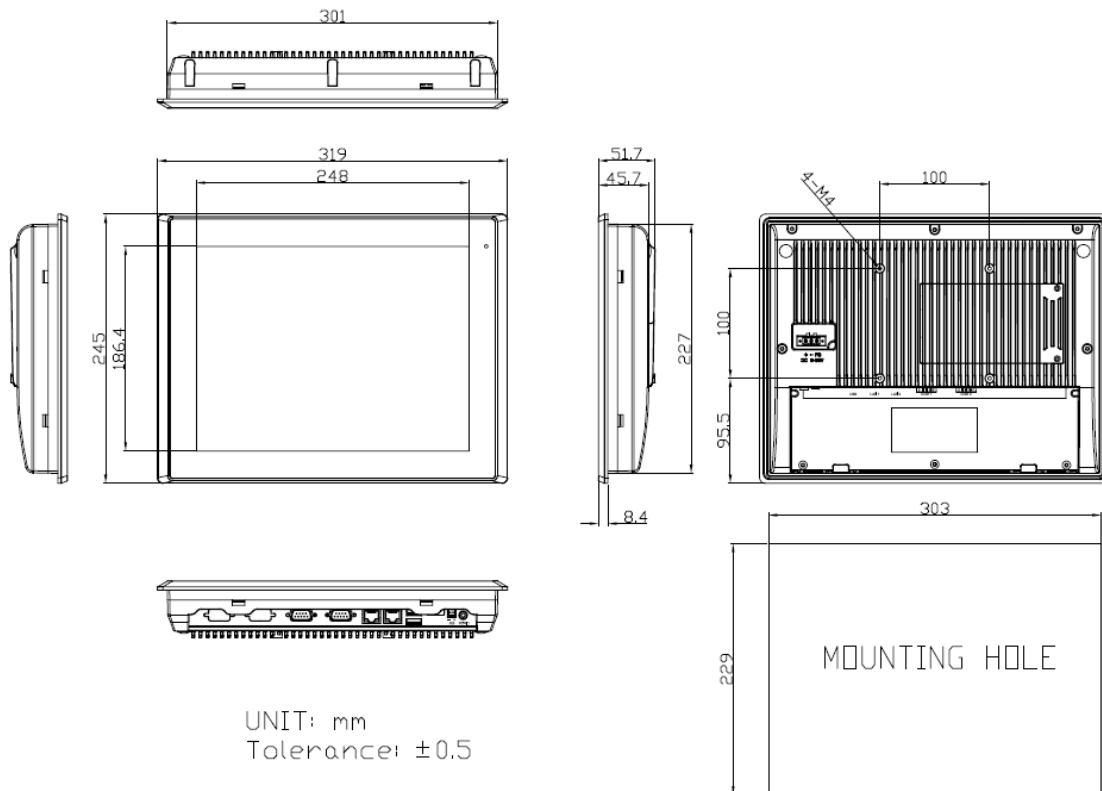

Figure 1.4: Dimensions of AS47CN12

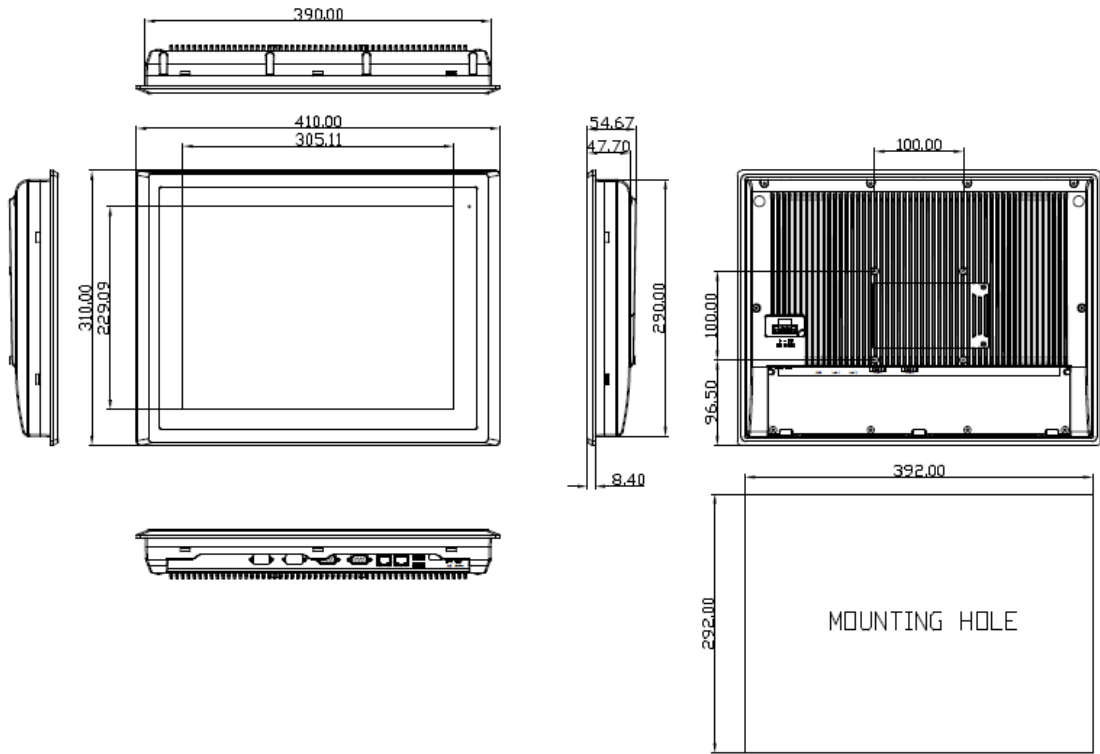

Figure 1.5: Dimensions of AS47CN15

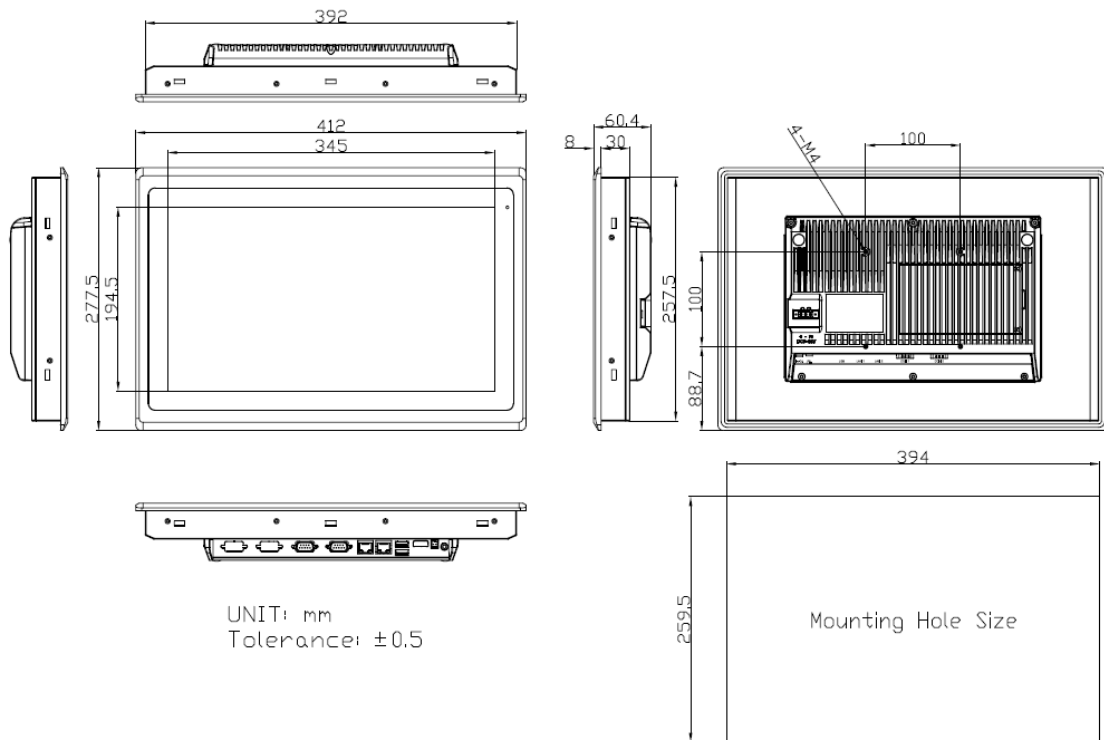

Figure 1.6: Dimensions of AS47CN16 (Resistive Touch)

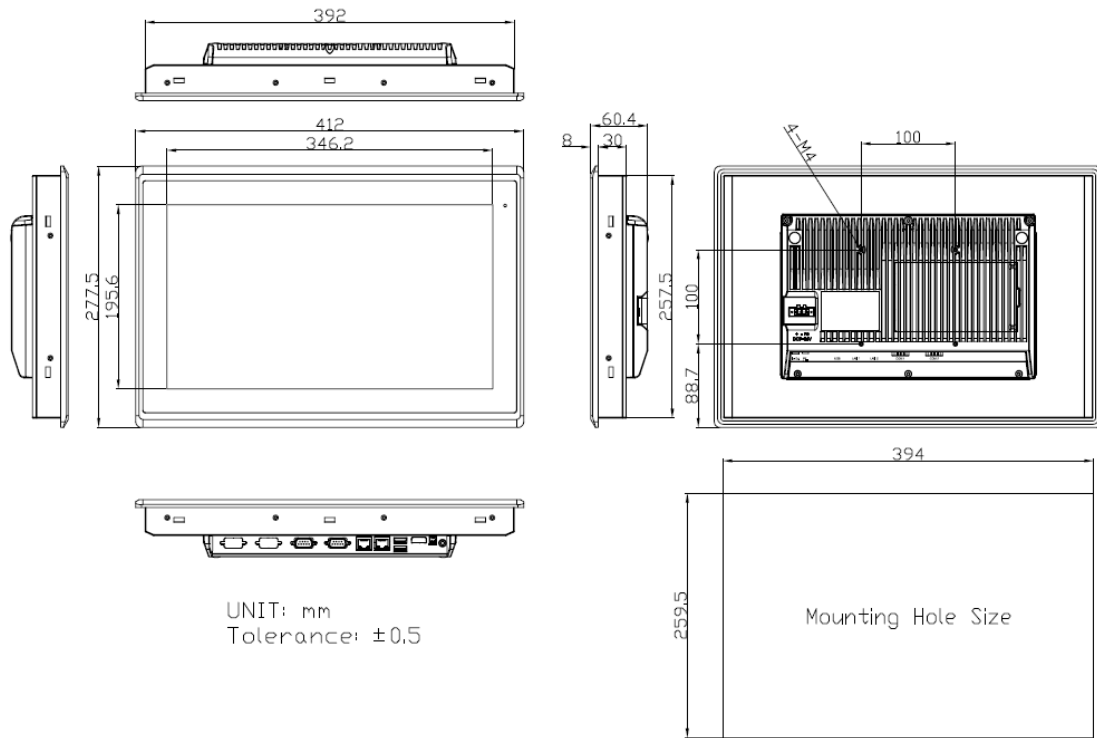

Figure 1.7: Dimensions of AS47CN16 (Projected Capacitive Touch)

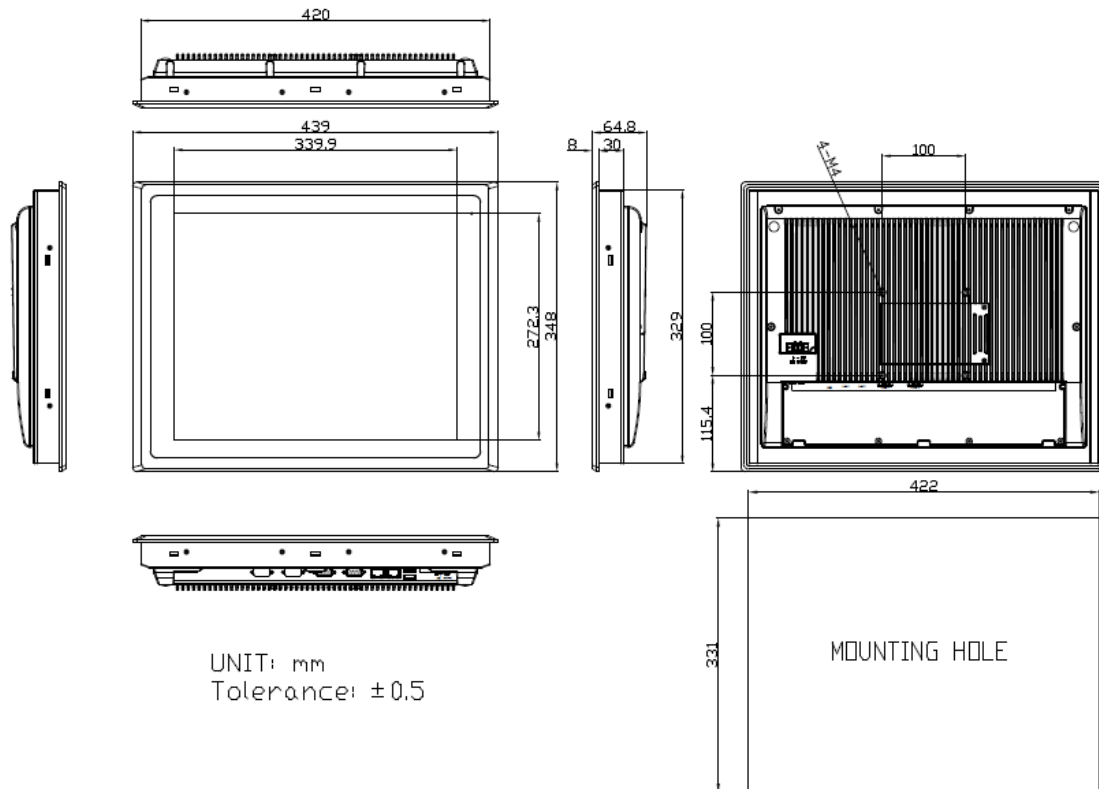

Figure 1.8: Dimensions of AS47CN17

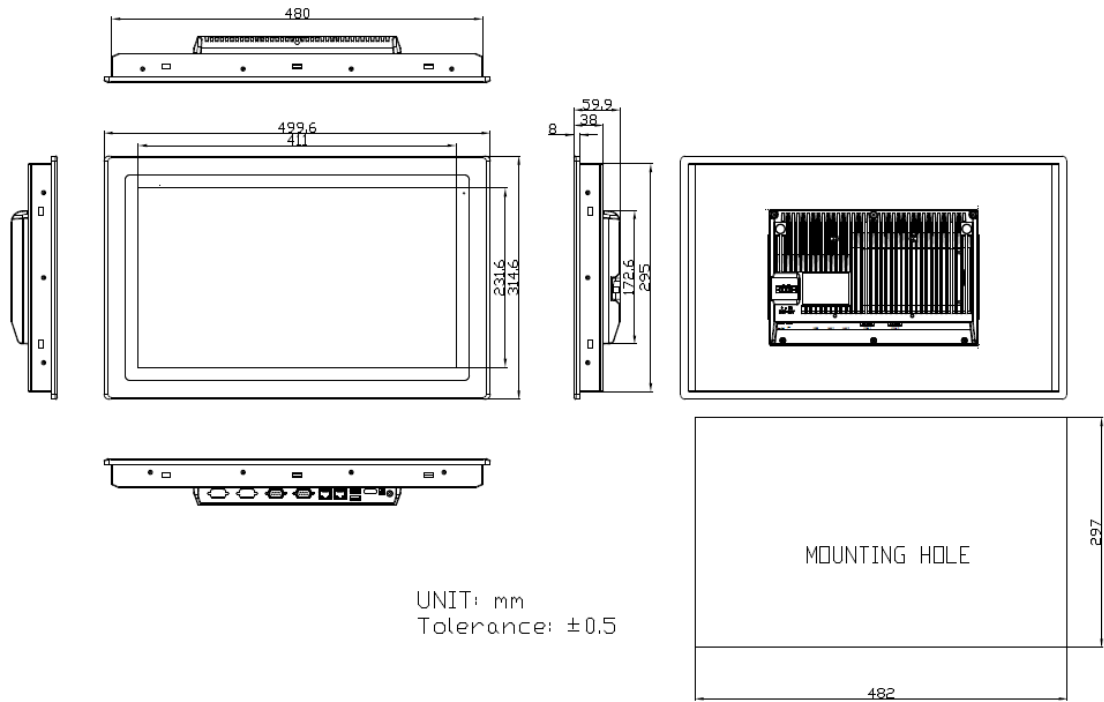

Figure 1.9: Dimensions of AS47CN18

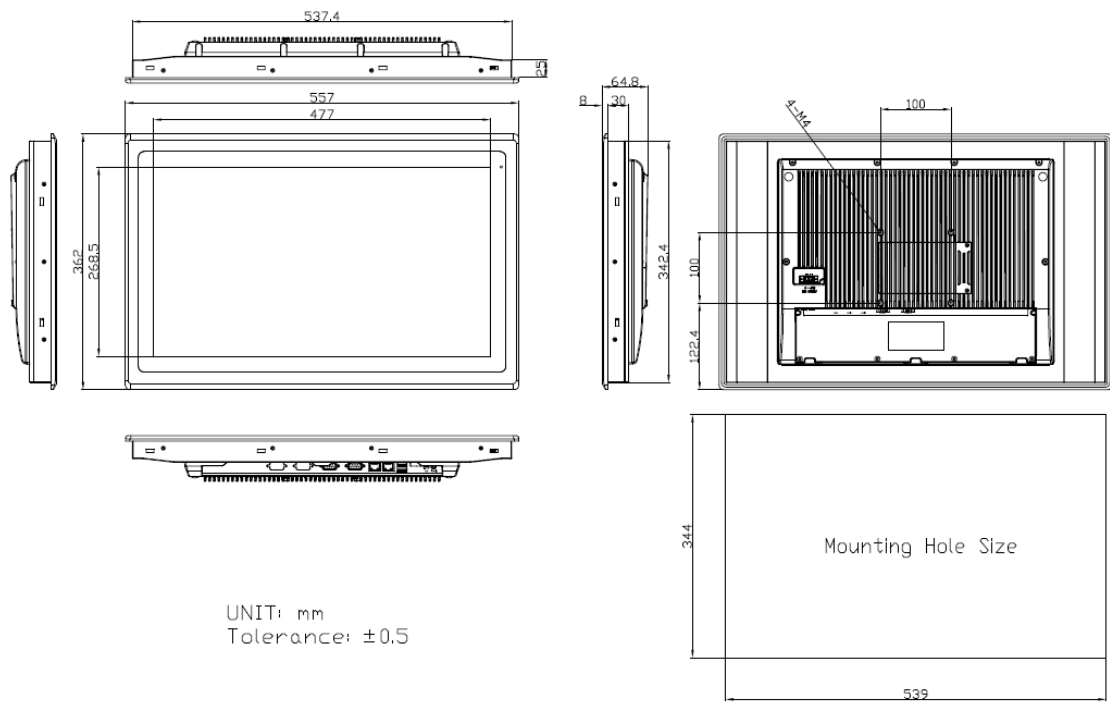

Figure 1.10: Dimensions of AS47CN21 (Resistive Touch)

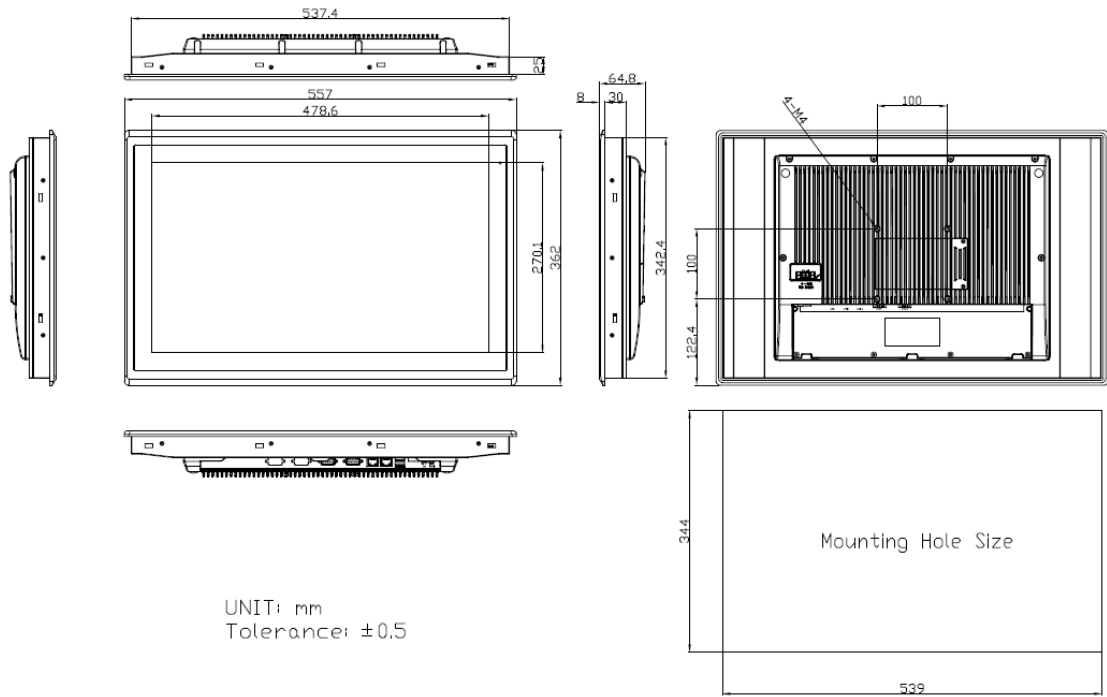

Figure 1.11: Dimensions of AS47CN21 (Projected Capacitive Touch)

1.4 Brief Description of AS47CN

There are 7", 8", 10.1", 12.1", 15", 15.6", 17", 18.5" and 21.5" Industrial Compact Size Panel PC in AS47CN series, which comes with flat front panel touch screen and fanless design. It is powered by Intel Bay Trail E3845(1.91GHz) or N2930(1.83GHz) CPU built-in, 2GB DDR3L 1600 MHz (4GB is for option). AS47CN series is 9~36V DC wide-ranging power input and IP65 compliant front panel. Optional projected capacitive touch support 7H anti-scratch surface is ideal for use as PC-based controller for Industrial Automation & Factory Automation.



Figure 1.12: Front View of AS47CN Series



Figure 1.13: Rear View of AS47CN07/AS47CN08



Figure 1.14: Rear View of AS47CN10



Figure 1.15: Rear View of AS47CN12



Figure 1.16: Rear View of AS47CN15



Figure 1.17: Rear View of AS47CN16



Figure 1.18: Rear View of AS47CN17



Figure 1.19: Rear View of AS47CN18



Figure 1.20: Rear View of AS47CN21

1.5 Installation of HDD – 7” and 8”

Step 1

There are two screws to deal with when enclosing or removing the chassis.

Gently remove two screws.

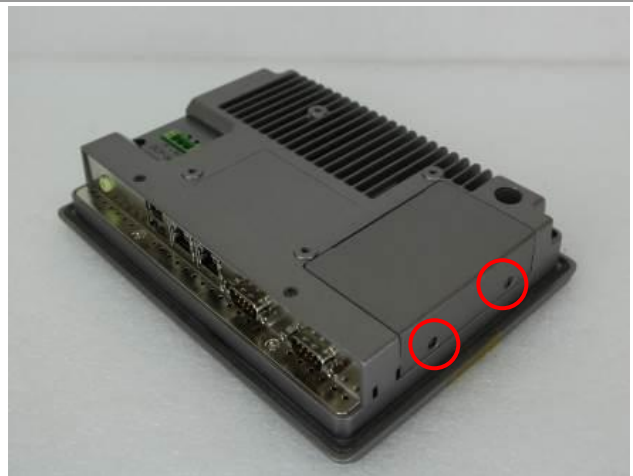

Step 2

There is a SSD card in the bracket. Gently remove the screw, then carefully pull SSD card.



Step 3

Take out SSD Card bracket.



Step 4

You can replace SSD card by unscrewing four screws as shown in the picture.

Note: four screws are packed in the packing list.

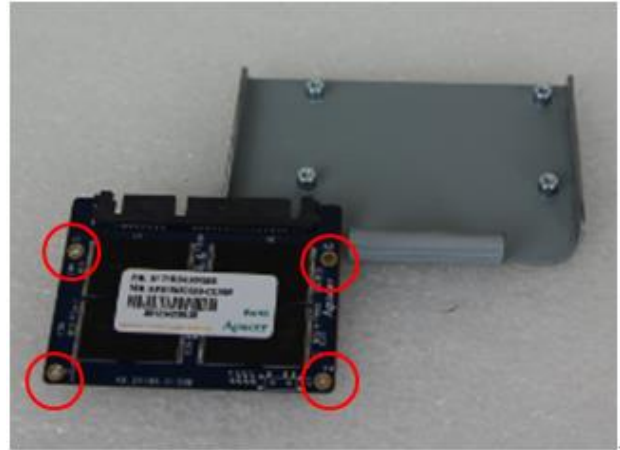

Step 5

There is a SD card hole in the side of the machine. You can replace SD card from there.



Step 6

Gently screw the screws.



1.6 Installation of HDD – 10.1”/15.6”/18.5”

Step 1

There are two screws to deal with when enclosing or removing the chassis.

Gently remove two screws.



Step 2

Take the storage cover beside the HMI.



Step 3

You can put or remove HDD into the machine by pulling the HDD bracket.



Step 4

There is a SD hole in the side of machine.

You can replace SD card from there.



1.7 Installation of HDD – 12.1”/15”/17”/21.5”

Step 1

There are 2 screws to deal with when enclosing or removing the chassis. Gently remove 2 screws.



Step 2

You can put or remove HDD into the machine by pulling the HDD bracket.



Step 3

You can remove HDD by unscrewing 4 screws in the HDD bracket.

Note: 4 screws are packed in the packing package.



Step 4

There is a SD hole in the side of machine.
You can replace SD card from there.



1.8 VESA Mounting

The AS47CN series is designed to be VESA mounted as shown in Picture. Just carefully place the unit through the hole and tighten the given screws from the rear to secure the mounting.

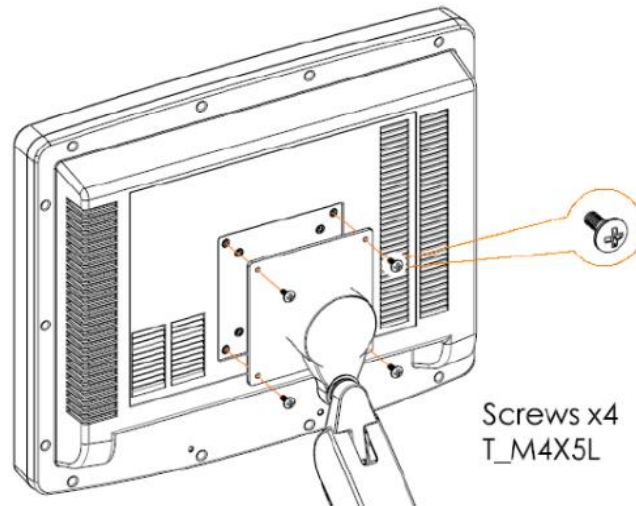

Figure 1.21: AS47CN16 Series VESA Mounting

1.9 Panel Mounting

There are four holes located along the four sides of the HMI. Insert the clamp from the four sides and tighten them with the nuts provided.

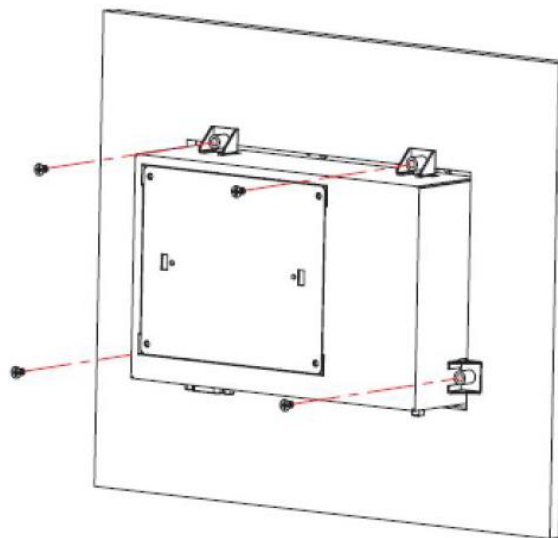

Figure 1.22: AS47CN16 Series Panel Mounting

2.1 Motherboard Introduction

SBC-7111 is a 4" industrial motherboard developed on the basis of Intel Bay trail-I/M Processors, which provides abundant peripheral interfaces to meet the needs of different customers. Also, it features dual GbE ports, 3-COM ports and one Mini PCIE configuration, one VGA port, one HDMI port, one LVDS interface. To satisfy the special needs of high-end customers, CN1 and CN2 and CN3 richer extension functions. The product is widely used in various sectors of industrial control.

2.2 Specifications

Specifications	
Board Size	170mm x 113mm
CPU Support	Intel Bay Trail E3845 / 1.91GHz (4cores, 10W, onboard) Intel Bay Trail N2930 / 1.83 up to 2.16GHz (4cores,TDP/7.5W, option) Intel Bay Trail E3815 / 1.46GHz (1core, 5W, option)
Chipset	SoC
Memory Support	Onboard 2GB DDR3L SDRAM (E3845/N2930/E3815, option) Onboard 4GB DDR3L SDRAM (E3845/N2930, option)
Graphics	Intel® HD Graphics 542/792MHz (E3845) Intel® HD Graphics 313/854MHz (N2930) Intel® HD Graphics 400MHz (E3815)
Display Mode	1 x HDMI Port 1 x LVDS (18/24-bit dual LVDS) 1 x CRT Port
Support Resolution	Up to 1920 x 1200 for HDMI Up to 1920 x 1200 for LVDS (PS8625) Up to 1920 x 1200 for CRT
Dual Display	HDMI + LVDS HDMI + CRT LVDS + CRT
Super I/O	ITE IT8518E

	Fintek F81216AD
BIOS	AMI/UEFI
Storage	1 x SATAII Connector (7P) 1 x SATAII Connector (7P + 15P) 1 x SD Slot
Ethernet	2 x PCIe Gbe LAN by Intel 82574L
USB	1 x USB 2.0 and 1 x USB 3.0 (type A)stack ports (USBCON1/USB0,USB1) 1 x USB 2.0 Pin header for CN1 (USB3 or Touch, option) 1 x USB 2.0 Hub(USB2) 1 x USB 2.0 Pin header for CN2 (USB Hub /USB1) 2 x USB 2.0 Pin header for CN3 (USB Hub /USB2/USB3) 1 x USB 2.0 for MPCIE1 (USB Hub /USB4)
Serial	1 x RS232/RS422/RS485 port, DB9 connector for external (COM1) Pin 9 w/5V/12V/Ring select 1 x RS232 port, DB9 connector for external (COM2) Pin 9 w/5V/12V/Ring select 2 x UART for CN3 (COM3,COM4) 1 x RS422/485 header for CN2 (IT8518E/COM5)
Digital I/O	8-bit digital I/O by Pin header (CN2) 4-bit digital Input 4-bit digital Output 4-bit digital I/O by Pin header (CN3) 2-bit digital Input 2-bit digital Output
Battery	Support CR2477 Li battery by 2-pin header (BAT1/CMOS)
Smart Battery	1 x Smart battery Support 3 Serial Li battery by 8-pin header (BAT2)
Audio	Support Audio via Realtek ALC662-VD HD audio codec Support Line-in, Line-out, MIC by 2x6-pin header
Keyboard /Mouse	1 x PS2 keyboard/mouse by box pin header (CN3)
Expansion Bus	1 x mini-PCI-express slot 1 x PCI-express (CN3)
Touch Ctrl	1 x Touch ctrl header for TCH1 (ITE8518E/COM6) (JP4 setting: RS232 or USB 2.0)

Power Management	Wide Range DC9V~36V input 1 x 3-pin power input connector
Switches and LED Indicators	1 x Power on/off switch (BT1/BT2/CN2/CN3) 1 x Reset (CN2) 1 x Power LED status (CN1) 1 x HDD LED status (CN2) 1 x Buzzer
External I/O port	2 x COM Ports (COM1/COM2) 2 x USB 2.0 Ports (stack) 2 x RJ45 GbE LAN Ports 1 x HDMI Port 1 x Stack audio Jack (Line out)
Watchdog Timer	Software programmable 1 – 255 second by Super I/O (Reserve)
Temperature	Operating: -20°C to 70°C Storage: -40°C to 85°C
Humidity	10% - 90%, non-condensing, operating
Power Consumption	2V /0.80A (Intel Bay Trail E3845 processor with 4GB DDR3L DRAM) 12V /0.70A (Intel Bay Trail N2930 processor with 4GB DDR3L DRAM) 12V /0.60A (Intel Bay Trail E3815 processor with 2GB DDR3L DRAM)
EMI/EMS	Meet CE/FCC class A
TB-528CAN2	2 x CAN bus
	1 x SIM Card Socket
	1 x mini-PCI-express slot

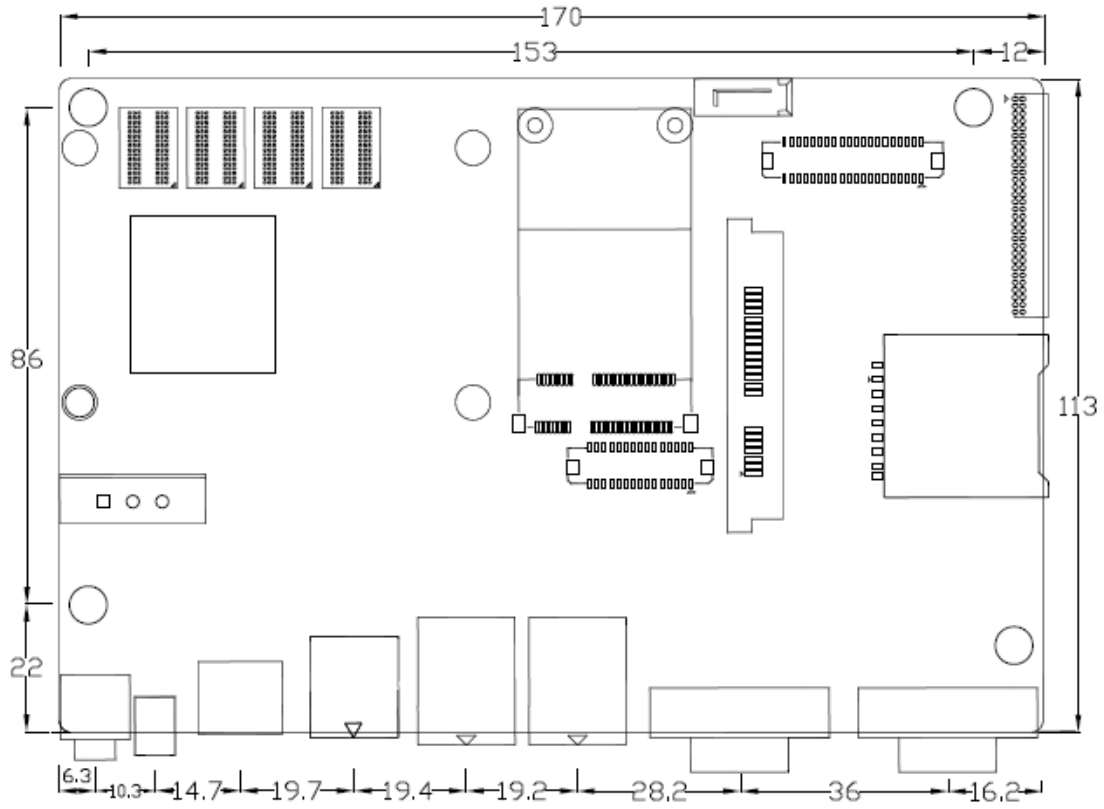

(units :mm)

Figure 2.1: Motherboard Dimensions

2.3 Jumpers and Connectors Location

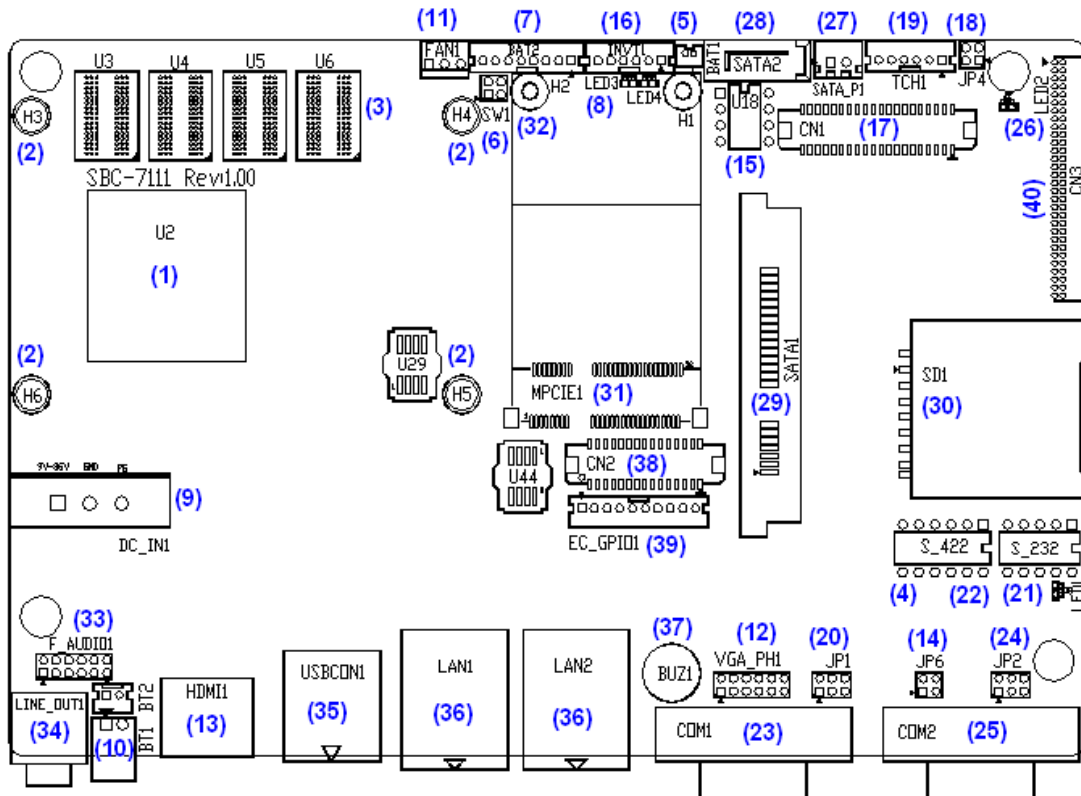

Figure 2.2: Jumpers and Connectors Location- Board Top

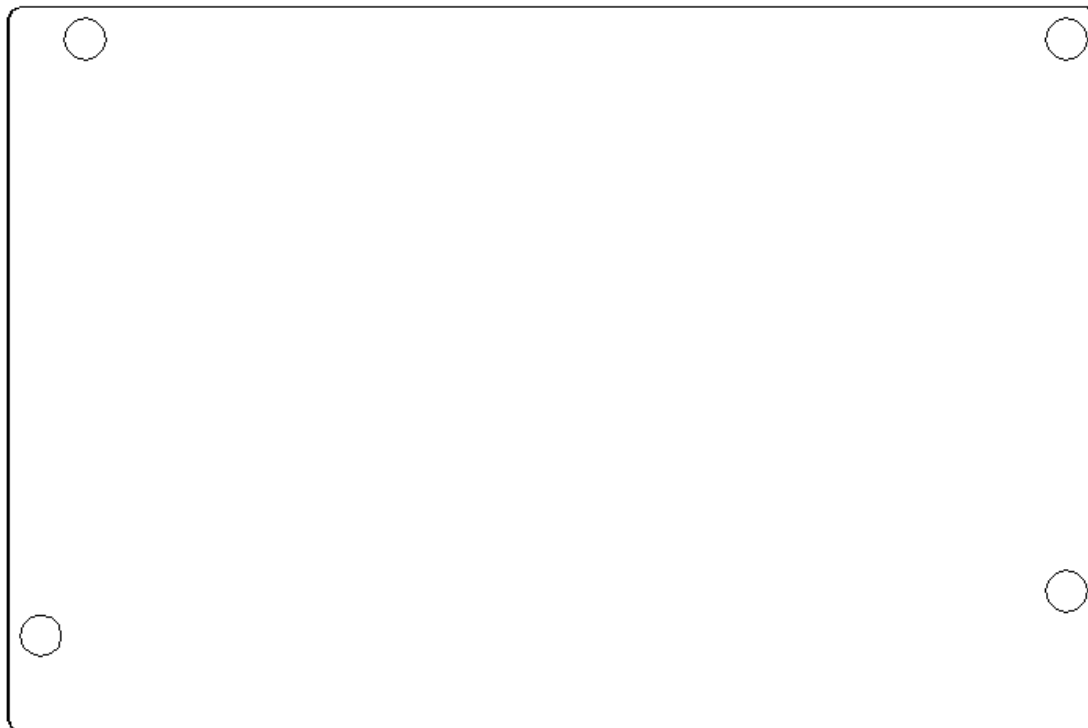

Figure 2.3: Jumpers and Connectors Location- Board Bottom

2.4 Jumpers Setting and Connectors

1. U2:

(FCBGA1170), onboard Intel Bay trail-I/M Processors.

Model	Processor				
	Number	PBF	Cores/Threads	TDP	Remarks
SBC-7111-E3845-2G	E3845	1.91GHz	4 / 4	10W	
SBC-7111-E3845-4G	E3845	1.91GHz	4 / 4	10W	Option
SBC-7111-N2930-2G	N2930	1.83 up to 2.16GHz	4 / 4	4.5 / 7.5W	Option
SBC-7111-N2930-4G	N2930	1.83 up to 2.16GHz	4 / 4	4.5 / 7.5W	Option
SBC-7111-E3815-2G	E3815	1.46GHz	1 / 1	5W	Option

2. H3/H4/H5/H6 (option):

U2 Heat Sink Screw holes, four screw holes for Intel Bay trail-I/M Processors Heat Sink assemble.

3. U3/U4/U5/U6:

(FBGA96), Onboard DDR3L Memory.

Model	Memory
SBC-7111-E3845-2G	2GB
SBC-7111-N2930-2G	2GB (option)
SBC-7111-E3815-2G	2GB (option)
SBC-7111-E3845-4G	4GB (option)
SBC-7111-N2930-4G	4GB (option)

4. S-422 (PIN6):

(Switch), ATX Power and Auto Power on jumper setting.

S-422(Switch)	Mode
Pin6 (Off)	ATX Power
Pin6 (On)	Auto Power on (Default)

5. BAT1:

(1.25mm Pitch 1x2 Wafer Pin Header) 3.0V Li battery is embedded to provide power for CMOS.

Pin#	Signal Name

1	VBAT
2	Ground

6. SW1 (NC) :

(2.0mm Pitch 2x2 Pin Header), Reserve.

7. BAT2 (NC) :

(2.0mm Pitch 1x8 Wafer Pin Header), Reserve.

8. LED3/LED4 (NC) :

LED3: Reserve.

LED4: Reserve.

9. DC_IN1:

(5.08mm Pitch 1x3 Pin Connector), DC9V~36V System power input connector.

Pin#	Power input
1	DC+9V~36V
2	Ground
3	FG

Model	DC_IN1
SBC-7111-E3845-2G	180°Connector
SBC-7111-E3845-4G	180°Connector
SBC-7111-N2930-2G	180°Connector
SBC-7111-N2930-4G	180°Connector
SBC-7111-E3815-2G	180°Connector
SBC-7111-E3845P-2G	45°Connector
SBC-7111-E3845P-4G	45°Connector

10. BT1/BT2:

Power on/off button, They are used to connect power switch button. The two pins are disconnected under normal condition. You may short them temporarily to realize system startup & shutdown or awaken the system from sleep state.

11. FAN1(option):

(2.54mm Pitch 1x3 Pin Header), Fan connector, cooling fans can be connected directly for use. You may set the rotation condition of cooling fan in menu of BIOS CMOS Setup.



Pin#	Signal Name
1	Ground
2	VCC
3	Rotation detection



Note:

Output power of cooling fan must be limited under 5W.

12. VGA_PH1:

(CRT 2.0mm Pitch 2x6 Pin Header), Video Graphic Array Port, Provide 2x6Pin cable to VGA Port.

Signal Name	Pin#	Pin#	Signal Name
CRT_RED	1	2	Ground
CRT_GREEN	3	4	Ground
CRT_BLUE	5	6	VGA_EN
CRT_H_SYNC	7	8	CRT_DDCDATA
CRT_V_SYNC	9	10	CRT_DDCCLK
Ground	11	12	Ground

VGA hot plug setting for Windows XP:	
VGA1 (Pin Header)	Function
Pin4-Pin6 (Close)	VGA Simulation Disabled
Pin4-Pin6 (Open)	VGA Simulation Enabled
Use the 2.0mm jumper cap to close pin4 and pin6	

13. HDMI1:

(HDMI 19P Connector), High Definition Multimedia Interface connector.

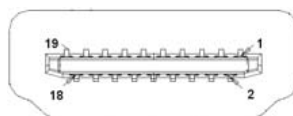

14. JP6:

(2.0mm Pitch 2x2 Pin Header), LVDS jumper setting.

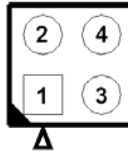

JP6	Function (CN1)
Pin1-Pin2 (Close)	Single channel LVDS
Pin1-Pin2 (Open)	Dual channel LVDS (Default)
Pin3-Pin4 (Close)	8/24 bit (Default)
Pin3-Pin4 (Open)	6/18 bit

15. U18:

AT24C02-DIP8, The EEPROM IC (U18) is the set of LVDS resolution. If you need other resolution settings, please upgrade U18 data.

Model	LVDS resolution
SBC-7111-E3845-2G	1280*1024 (Default)
SBC-7111-E3845-4G	800*480 (option)
SBC-7111-N2930-2G	800*600 (option)
SBC-7111-E3845-4G	1024*768 (option)
SBC-7111-E3815-2G	1920*1080 (option)

16. INVT1:

(2.0mm Pitch 1x6 wafer Pin Header), Backlight control connector for LVDS.

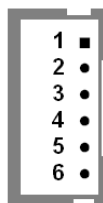

Pin#	Signal Name
1	+DC12V
2	+DC12V
3	Ground
4	Ground
5	BKLT_EN_OUT
6	BKLT_CTRL

17. CN1:

(1.25mm Pitch 2x20 Connector, DF13-40P), for 18/24-bit LVDS output connector, fully supported by Parad PS8625(DP to LVDS), the interface features dual channel 24-bit output. Low Voltage Differential Signaling, A high speed, low power data transmission standard used for display connections to LCD panels.

Function	Signal Name	Pin#	Pin#	Signal Name	Function
LVDS	12V_S0	2	1	12V_S0	LVDS
	BKLT_EN_OUT	4	3	BKLT_CTRL	
	Ground	6	5	Ground	
	LVDS_VDD5	8	7	LVDS_VDD5	
	LVDS_VDD3	10	9	LVDS_VDD3	
	Ground	12	11	Ground	
	LA_D0_P	14	13	LA_D0_N	
	LA_D1_P	16	15	LA_D1_N	
	LA_D2_P	18	17	LA_D2_N	
	LA_D3_P	20	19	LA_D3_N	
	LA_CLKP	22	21	LA_CLKN	
	LB_D0_P	24	23	LB_D0_N	
	LB_D1_P	26	25	LB_D1_N	
	LB_D2_P	28	27	LB_D2_N	
LB_D3_P	30	29	LB_D3_N		
	LB_CLKP	32	31	LB_CLKN	
	Ground	34	33	Ground	USB3 (JP4 open)
USB3 (JP4 open)	USB3_P	36	35	USB3_N	
	5V_S5_USB	38	37	5V_S5_USB	
Power LED	PWR_LED+	40	39	Ground	Power LED

18. JP4:

(2.0mm Pitch 2x2 wafer Pin Header), USB3(CN1) or Touch jumper setting.

JP4	Function	
	USB3 (CN1)	Touch (TCH1)
Close 3-4 (default)	-	Yes
Open 3-4 (option)	Yes	-
Open 1-2 (default)	-	

19. TCH1:

(2.0mm Pitch 1x6 wafer Pin Header), internal Touch controller connector.

Pin#	Signal Name
1	SENSE
2	X+
3	X-
4	Y+
5	Y-
6	GND_EARCH

20. JP1:

(2.0mm Pitch 2x3 Pin Header), COM1 jumper setting, pin 1~6 are used to select signal out of pin 9 of COM1 port.

JP1 Pin#	Function
Close 1-2	COM1 RI (Ring Indicator) (default)
Close 3-4	COM1 Pin9: DC+5V (option)
Close 5-6	COM1 Pin9: DC+12V (option)

21. S_232:

(Switch), COM1 jumper setting, it provides selectable RS232 or RS422 or RS485 serial signal output.

Function	S_232 Pin#
RS232 (Default)	ON: Pin1, Pin2, Pin3, Pin4
RS422 (option)	OFF: Pin1, Pin2, Pin3, Pin4
RS485 (option)	OFF: Pin1, Pin2, Pin3, Pin4

22. S_422:

(Switch), COM1 setting, it provides selectable RS232 or RS422 or RS485 serial signal output.

Function	S_422 Pin#
RS232 (Default)	OFF: Pin1, Pin2, Pin3, Pin4, Pin5
RS422 (option)	ON: Pin1, Pin2, Pin3, Pin4, Pin5
RS485 (option)	ON: Pin1, Pin2, Pin3, Pin4, Pin5

S-422	Mode
Pin6 (Off)	ATX Power
Pin6 (On)	Auto Power on (Default)

23. COM1:

(Type DB9M), Rear serial port, standard DB9 Male serial port is provided to make a direct connection to serial devices. COM1 port is controlled by pins

No.1~6 of JP1, select output Signal RI or 5V or 12V, for details, please refer to description of JP1 and S_232 and S_422 setting.

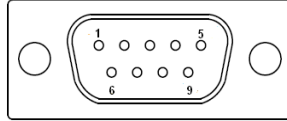

RS232 (Default)	
Pin#	Signal Name
1	DCD# (Data Carrier Detect)
2	RXD (Received Data)
3	TXD (Transmit Data)
4	DTR (Data Terminal Ready)
5	Ground
6	DSR (Data Set Ready)
7	RTS (Request To Send)
8	CTS (Clear To Send)
9	JP1 select Setting (RI/5V/12V)
BIOS Setup: Advanced/F81216SEC Super IO Configuration/Serial Port 1 Configuration 【RS-232】	

RS422 (option)	
Pin#	Signal Name
1	422_RX+
2	422_RX-
3	422_TX-
4	422_TX+
5	Ground
6	NC
7	NC
8	NC
9	NC
BIOS Setup: Advanced/F81216SEC Super IO Configuration/Serial Port 1 Configuration 【RS-422】	

RS485 (option)	
Pin#	Signal Name
1	NC

2	NC
3	485-
4	485+
5	Ground
6	NC
7	NC
8	NC
9	NC
BIOS Setup: Advanced/F81216SEC Super IO Configuration/Serial Port 1 Configuration 【RS-485】	

24. JP2:

(2.0mm Pitch 2x3 Pin Header), COM2 jumper setting, pin 1~6 are used to select signal out of pin 9 of COM2 port.

JP2 Pin#	Function
Close 1-2	COM2 RI (Ring Indicator) (default)
Close 3-4	COM2 Pin9: DC+5V (option)
Close 5-6	COM2 Pin9: DC+12V (option)

25. COM2:

(Type **DB9M**), Rear serial port, standard DB9 Male serial port is provided to make a direct connection to serial devices.

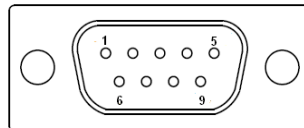

Pin#	Signal Name
1	DCD# (Data Carrier Detect)
2	RXD (Received Data)
3	TXD (Transmit Data)
4	DTR (Data Terminal Ready)
5	Ground
6	DSR (Data Set Ready)
7	RTS (Request To Send)
8	CTS (Clear To Send)
9	JP2 select Setting (RI/5V/12V)

26. LED1, LED2 (option) :

LED1: LED STATUS. Green LED for Motherboard Standby Power Good status.

LED2: LED STATUS. Green LED for Touch Power status.

27. SATA_P:

(2.5mm Pitch 1x2 box Pin Header), One onboard 5V output connector are reserved to provide power for SATA devices.

Pin#	Signal Name
1	+DC5V
2	Ground



Note:

Output current of the connector must not be above 1A.

28. SATA2:

(SATA 7Pin), SATA Connectors, one SATA connector are provided, with transfer speed up to 3.0Gb/s.

29. SATA1:

(SATA 7Pin+15Pin), SATA Connectors, one SATA connector are provided, with transfer speed up to 3.0Gb/s.

30. SD1:

(SD card slot), Secure Digital Memory Card socket.

31. MPCIE1:

(Socket 52Pin), mini PCIe socket, it is located at the top, it supports mini PCIe devices with USB2.0 and LPC and SMBUS and PCIe signal. MPCIE card size is 30x50.95mm.

32. H1/H2:

MPCIE1 SCREW HOLES, H1and H2 for mini PCIE card (30mmx50.95mm) assemble.

33. F_AUDIO1:

(2.0mm Pitch 2X6 Pin Header), Front Audio, An onboard Realtek ALC662-VD codec is used to provide high-quality audio I/O ports. Line Out can be connected to a headphone or amplifier. Line In is used for the connection of external audio source via a Line in cable. MIC is the port for microphone input audio.

Signal Name	Pin#	Pin#	Signal Name
+5V	1	2	GND_AUD

LINE-OUT-L	3	4	LINE-OUT-R
FRONT_JD	5	6	LINE1_JD
LINE_IN-L	7	8	LINE-IN-R
MIC-IN-L	9	10	MIC-IN-R
GND-AUD	11	12	MIC1_JD

34. LINE_OUT1:

(Diameter 3.5mm Jack), HD Audio port, an onboard Realtek ALC662-VD codec is used to provide high quality audio I/O ports. Line Out can be connected to a headphone or amplifier.



35. USBCON1:

USB0/USB1: (Double stack USB type A), Rear USB connector, it provides up to two USB2.0 port, High-speed USB 2.0 allows data transfers up to 480 Mb/s, support USB full-speed and low-speed signaling.

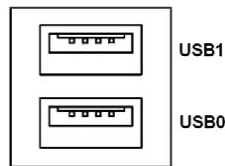

Each USB Type A Receptacle (2 Ports) Current limited value is 1.5A.

If the external USB device current exceeds 1.5A, please separate connectors into different Receptacle.

36. LAN1/LAN2:

LAN1/LAN2: (RJ45 Connector), Rear LAN port, Two standard 10/100/1000M RJ-45 Ethernet ports are provided. Used intel 82574L chipset, LINK LED (green) and ACTIVE LED (yellow) respectively located at the left-hand and right-hand side of the Ethernet port indicate the activity and transmission state of LAN.

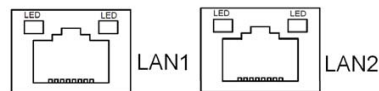

37. BUZ1:

Onboard buzzer.

38. CN2:

(DF13-30P Connector) For expand output connector, It provides eight GPIO, one RS422 or RS485, one USB2.0, one Power on/off, one Reset.

Function	Signal Name	Pin#	Pin#	Signal Name	Function
5V	5V_S5	2	1	5V_S5	5V
SOC_GPIO10	GPIO_IN2	4	3	GPIO_IN1	SOC_SPIO09
SOC_GPIO26	GPIO_IN4	6	5	GPIO_IN3	SOC_GPIO17
SOC_GPIO05	GPIO_OUT2	8	7	GPIO_OUT1	SOC_GPIO04
SOC_GPIO08	GPIO_OUT4	10	9	GPIO_OUT3	SOC_GPIO06
	Ground	12	11	Ground	
485 or 422	485+_422TX+	14	13	485-_422TX-	485 or 422
RS422	422_RX+	16	15	422_RX-	RS422
	NC	18	17	NC	
	NC	20	19	NC	
5V	5V_S0	22	21	HDD_LED+	HDD LED
USB2.0	5V_USB01	24	23	5V_USB01	USB2.0
	USBDN1_P	26	25	USBDN1_N	
	Ground	28	27	FP_RST-	RESET
Power auto on	PWRBTN_ON	30	29	Ground	
COM5 BIOS Setup: Advanced/IT8518Super IO Configuration/Serial Port 1 Configuration 【RS-422】 Advanced/IT8518Super IO Configuration/Serial Port 1 Configuration 【RS-485】					

39. EC_GPIO1:

(2.0mm Pitch 1X10 Pin Header), For expand connector, it provides eight GPIO.

Pin#	Signal Name
1	Ground
2	EC_GPIO1
3	EC_GPIO2
4	EC_GPIO3
5	EC_GPIO4
6	EC_GPIO5
7	EC_GPIO6
8	EC_GPIO7
9	EC_GPIO8
10	3.3V

40. CN3:

(1.27mm Pitch 2X30 Female Header), for expand output connector, it provides four GPIO, two USB 2.0, one PS/2 mouse, one PS/2 keyboard, two uart, one PCIe1, one SMBus. connected to the TB-528 riser Card.

Function	Signal Name	Pin#	Pin#	Signal Name	Function
	5V_S5_USB	1	2	5V_S5_USB	
	5V_S5_USB	3	4	5V_S5_USB	
	USB23_OC	5	6	PSON_ATX-	
Exp-USB2	USB2_DM	7	8	USB2_DP	Exp-USB2
Exp-USB3	USB3_DM	9	10	USB3_DP	Exp-USB3
	Ground	11	12	Ground	
PS/2 MS	PS2_MSCLK	13	14	PS2_MSDATA	PS/2 MS
PS/2 KB	PS2_KBCLK	15	16	PS2_KBDATA	PS/2 KB
COM4 (UART)	COM4_RI	17	18	COM4_DCD-	COM4 (UART)
	COM4_TXD	19	20	COM4_RXD	
	COM4_DTR	21	22	RICOM4_RTS-	
	COM4_DSR	23	24	COM_CTS-	
	Ground	25	26	Ground	
COM3 (UART)	COM3_RI	27	28	COM3_DCD-	COM3 (UART)
	COM3_TXD	29	30	COM3_RXD	
	COM3_DTR	31	32	DSRCOM3_RTS-	
	COM3_DSR	33	34	DTRCOM3_CTS-	
GPIO23	SOC_GPIO23	35	36	ICH_GPIO22	GPIO12
GPIO25	SOC_GPIO25	37	38	ICH_GPIO24	GPIO24
	Ground	39	40	Ground	
PCIE	PCIE_TX0_DN	41	42	PCIE_TX0_DP	PCIE
	PCIE_RX0_DN	43	44	PCIE_RX0_DP	
	Ground	45	46	Ground	
	PCIE_REFCLK0_DN	47	48	PCIE_REFCLK0_DP	
	PCIE0_WAKE_N	49	50	PLTRST_3P3_N	
SMBUS	SMB_CLK_S0	51	52	SMB_DATA_S0	SMBUS
PCIE	PCIE_CLKREQ0_N	53	54	Ground	
	3P3V_S5	55	56	PWRBTN_ON-	Power Auto on
	3P3V_S5	57	58	3P3V_S5	
12V	12V_S0	59	60	12V_S0	12V

41. TB-528C2ME1 (option) :

SBC-7111 Riser Card, TB-528C2ME1 CN3 connect to SBC-7111 CN3 pin Header.

TB-528C2ME1 Top:

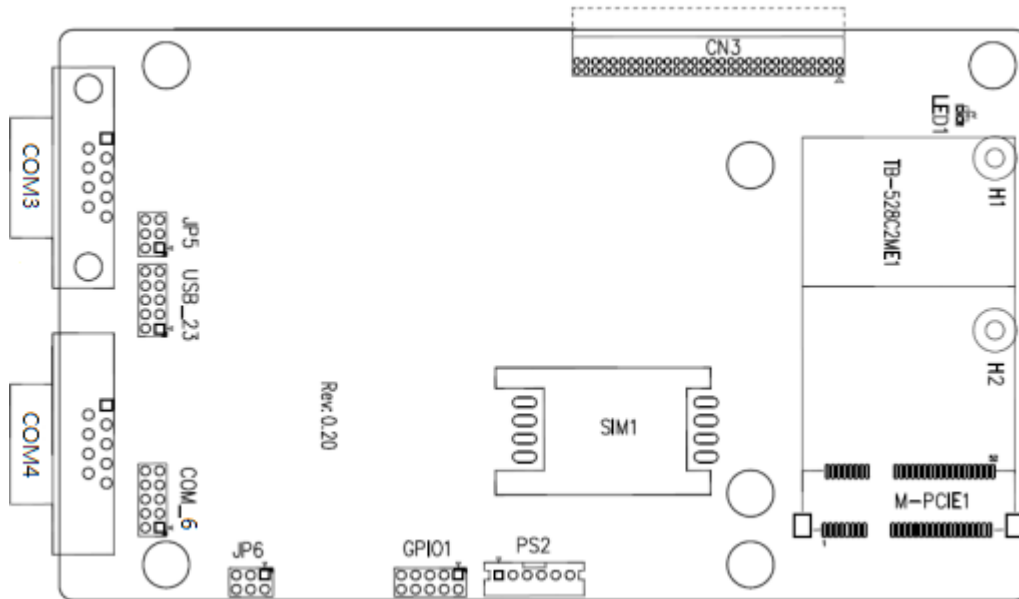

CN3:

(1.27mm Pitch 2X30 Pin Header), connect to SBC-7111 CN3 pin Header.

M-PCIE1:

(Socket 52Pin), mini PCIe socket, it is located at the top, it supports mini PCIe devices with **USB2.0(USB2)**, Smbus, SIM and PCIe signal. MPCie card size is 30x30mm or 30x50.95mm.

Signal Name	Function support
PCIe 1X	Yes
USB2.0 (USB2)	Yes
SMBus	Yes
SIM	Yes

H1/H2:

MPCIE1 SCREW HOLES, H2 for mini PCIE card (30mmx30mm) assemble. H1 for mini PCIE card (30mmx50.95mm) assemble.

LED1:

Mini PCIe devices LED Status.

SIM1:

(SIM Socket 6 Pin), support SIM Card devices.

PS2:

(2.0mm Pitch 1X6 Pin Wafer), PS/2 keyboard and mouse port, the port can be connected to PS/2 keyboard or mouse via a dedicated cable for direct used.

Pin#	Signal Name
1	KBDATA
2	MSDATA
3	Ground
4	+5V
5	KBCLK
6	MSCLK

GPIO1:

(2.0mm Pitch 2x5 Pin Header), General-purpose input/output port, it provides a group of self-programming interfaces to customers for flexible use.

Signal Name	Pin#	Pin#	Signal Name
Ground	1	2	NC
NC	3	4	SMB_DATA_R
SMB_CLK_R	5	6	SOC-GPIO22
SOC-GPIO23	7	8	SOC-GPIO25
SOC-GPIO24	9	10	+5V

USB_23:

(2.0mm Pitch 2x5 Pin Header), Front USB connector, it provides one USB port via a dedicated USB cable, speed up to 480Mb/s.

Signal Name	Pin#	Pin#	Signal Name
5V_USB23	1	2	5V_USB23
USB3_N	3	4	USB2_N (option, NC)
USB3_P	5	6	USB2_P (option, NC)
Ground	7	8	Ground
NC	9	10	Ground

**Note:**

Before connection, make sure that pinout of the USB Cable is in accordance with that of the said tables. Any inconformity may cause system down and

even hardware damages.

JP5:

(2.0mm Pitch 2x3 Pin Header), COM3 setting jumper, pin 1~6 are used to select signal out of pin 9 of COM3 port.

JP5 Pin#	Function
Close 1-2	RI (Ring Indicator) (default)
Close 3-4	COM3 Pin9=+5V (option)
Close 5-6	COM3 Pin9=+12V (option)

COM3:

(Type DB9), serial port, standard DB9 serial port is provided to make a direct connection to serial devices. COM3 port is controlled by pins No.1~6 of **JP5**, select output Signal RI or 5V or 12v, for details, please refer to description of JP5.

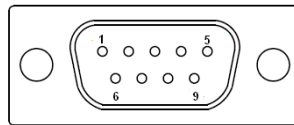

Pin#	Signal Name
1	DCD# (Data Carrier Detect)
2	RXD (Received Data)
3	TXD (Transmit Data)
4	DTR (Data Terminal Ready)
5	Ground
6	DSR (Data Set Ready)
7	RTS (Request To Send)
8	CTS (Clear To Send)
9	JP5 Setting: Pin1-2: RI (Ring Indicator) (default) Pin3-4 : 5V Standby power (option) Pin5-6: 12V Standby power (option)

JP6:

(2.0mm Pitch 2x3 Pin Header), COM4 setting jumper, pin 1~6 are used to select signal out of pin 9 of COM4 port.

JP6 Pin#	Function
----------	----------

Close 1-2	RI (Ring Indicator) (default)
Close 3-4	COM4 Pin9=+5V (option)
Close 5-6	COM4 Pin9=+12V (option)

COM4:

(Type DB9), serial port, standard DB9 serial port is provided to make a direct connection to serial devices. COM4 port is controlled by pins No.1~6 of **JP6**, select output Signal RI or 5V or 12v, for details, please refer to description of JP6.

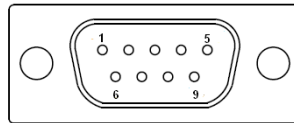

Pin#	Signal Name
1	DCD# (Data Carrier Detect)
2	RXD (Received Data)
3	TXD (Transmit Data)
4	DTR (Data Terminal Ready)
5	Ground
6	DSR (Data Set Ready)
7	RTS (Request To Send)
8	CTS (Clear To Send)
9	JP6 Setting: Pin1-2: RI (Ring Indicator) (default) Pin3-4 : 5V Standby power (option) Pin5-6: 12V Standby power (option)

COM_6 (option) :

(2.0mm Pitch 2X5 Pin Header), COM4 Port, up to one standard RS232 port are provided. They can be used directly via COM cable connection.

Signal Name	Pin#	Pin#	Signal Name
DCD	1	2	RXD
TXD	3	4	DTR
Ground	5	6	DSR
RTS	7	8	CTS
JP6 Setting: RI/5V/12V	9	10	NC

42. TB-528C2 (option) :

SBC-7111 Riser Card, TB-528C2 CN3 is connected to SBC-7111 CN3 pin Header.
 TB-528C2 Top:

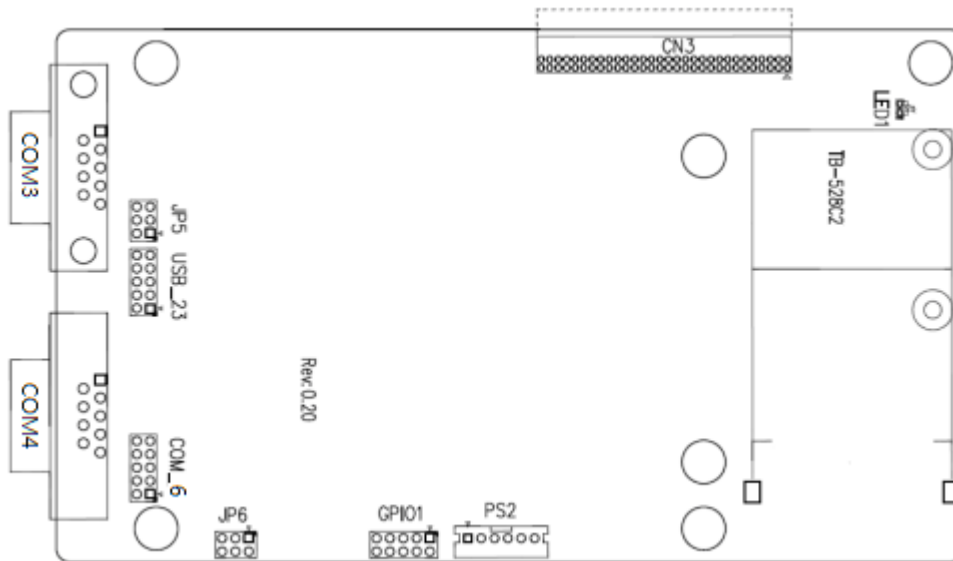

CN3:

(1.27mm Pitch 2X30 Pin Header), connect to SBC-7111 CN3 pin Header.

LED1:

Mini PCIe devices LED Status.

PS2:

(2.0mm Pitch 1X6 Pin Wafer), PS/2 keyboard and mouse port, the port can be connected to PS/2 keyboard or mouse via a dedicated cable for direct used.

Pin#	Signal Name
1	KBDATA
2	MSDATA
3	Ground
4	+5V
5	KBCLK
6	MSCLK

GPIO1:

(2.0mm Pitch 2x5 Pin Header), General-purpose input/output port, it provides a group of self-programming interfaces to customers for flexible use.

Signal Name	Pin#	Pin#	Signal Name
Ground	1	2	NC

NC	3	4	SMB_DATA_R
SMB_CLK_R	5	6	SOC-GPIO22
SOC-GPIO23	7	8	SOC-GPIO25
SOC-GPIO24	9	10	+5V

USB_23:

(2.0mm Pitch 2x5 Pin Header), Front USB connector, it provides one USB port via a dedicated USB cable, speed up to 480Mb/s.

Signal Name	Pin#	Pin#	Signal Name
5V_USB23	1	2	5V_USB23
USB3_N	3	4	USB2_N
USB3_P	5	6	USB2_P
Ground	7	8	Ground
NC	9	10	Ground



Note:

Before connection, make sure that pinout of the USB Cable is in accordance with that of the said tables. Any inconformity may cause system down and even hardware damages.

JP5:

(2.0mm Pitch 2x3 Pin Header), COM3 setting jumper, pin 1~6 are used to select signal out of pin 9 of COM3 port.

JP5 Pin#	Function
Close 1-2	RI (Ring Indicator) (default)
Close 3-4	COM3 Pin9=+5V (option)
Close 5-6	COM3 Pin9=+12V (option)

COM3:

(Type DB9), serial port, standard DB9 serial port is provided to make a direct connection to serial devices. COM3 port is controlled by pins No.1~6 of **JP5**, select output Signal RI or 5V or 12v, for details, please refer to description of JP5.

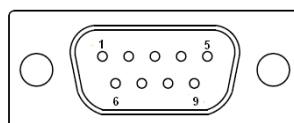

Pin#	Signal Name
1	DCD# (Data Carrier Detect)

2	RXD (Received Data)
3	TXD (Transmit Data)
4	DTR (Data Terminal Ready)
5	Ground
6	DSR (Data Set Ready)
7	RTS (Request To Send)
8	CTS (Clear To Send)
9	JP5 Setting: Pin1-2: RI (Ring Indicator) (default) Pin3-4 : 5V Standby power (option) Pin5-6: 12V Standby power (option)

JP6:

(2.0mm Pitch 2x3 Pin Header), COM4 setting jumper, pin 1~6 are used to select signal out of pin 9 of COM4 port.

JP6 Pin#	Function
Close 1-2	RI (Ring Indicator) (default)
Close 3-4	COM4 Pin9=+5V (option)
Close 5-6	COM4 Pin9=+12V (option)

COM4:

(Type DB9), serial port, standard DB9 serial port is provided to make a direct connection to serial devices. COM4 port is controlled by pins No.1~6 of **JP6**, select output Signal RI or 5V or 12v, for details, please refer to description of JP6.

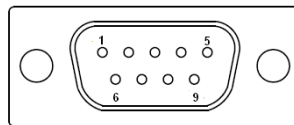

Pin#	Signal Name
1	DCD# (Data Carrier Detect)
2	RXD (Received Data)
3	TXD (Transmit Data)
4	DTR (Data Terminal Ready)
5	Ground
6	DSR (Data Set Ready)
7	RTS (Request To Send)
8	CTS (Clear To Send)
9	JP6 Setting:

	Pin1-2: RI (Ring Indicator) (default)
	Pin3-4 : 5V Standby power (option)
	Pin5-6: 12V Standby power (option)

COM_6 (option) :

(2.0mm Pitch 2X5 Pin Header), COM4 Port, up to one standard RS232 port are provided. They can be used directly via COM cable connection.

Signal Name	Pin#	Pin#	Signal Name
DCD	1	2	RXD
TXD	3	4	DTR
Ground	5	6	DSR
RTS	7	8	CTS
JP6 Setting: RI/5V/12V	9	10	NC

43. TB-528C1U2P1/TB-528C1U2 (option) :

SBC-7111 Riser Card, TB-528C1U2P1 CN3 connect to SBC-7111 CN3 pin Header.

TB-528C1U2P1 Top:

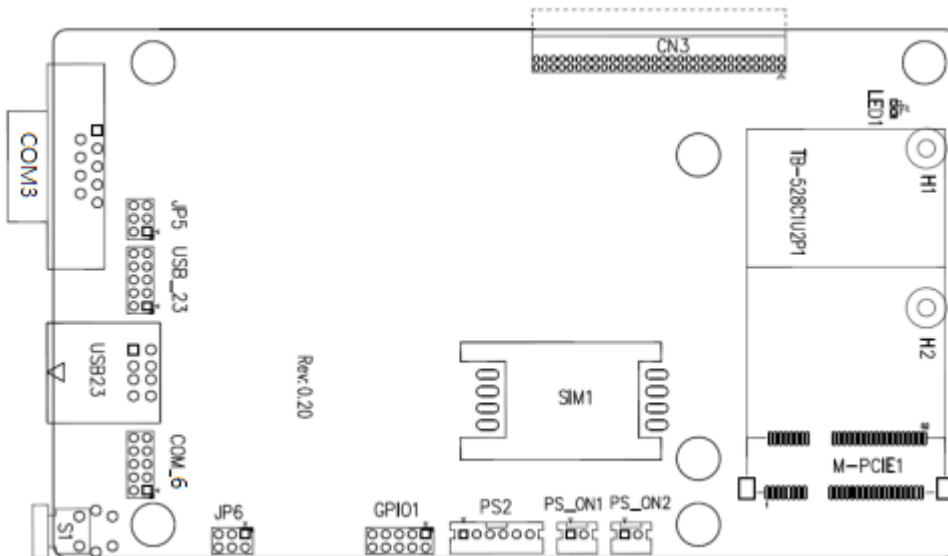

CN3:

(1.27mm Pitch 2X30 Pin Header), connect to SBC-7111 CN3 pin Header.

M-PCIE1:

(Socket 52Pin), mini PCIe socket, it is located at the top, it supports mini PCIe devices with Smbus, SIM and PCIe signal. MPCle card size is 30x30mm or 30x50.95mm.

Signal Name	Function support
-------------	------------------

PCIe 1X	Yes
USB2.0 (USB2)	NC (option)
SMBus	Yes
SIM	Yes

H1/H2:

MPCIE1 SCREW HOLES, H2 for mini PCIE card (30mmx30mm) assemble. H1 for mini PCIE card (30mmx50.95mm) assemble.

LED1:

Mini PCIe devices LED Status.

SIM1 (option) :

(SIM Socket 6 Pin), Support SIM Card devices.

PS_ON1:

(2.0mm Pitch 1X2 Pin Wafer), ATX Power and Auto Power on jumper setting.

PS_ON	Mode
Close 1-2	Auto Power on (Default)
Open 1-2	ATX Power

PS_ON2 (option) :

(2.0mm Pitch 1X2 Pin Wafer).

PS2:

(2.0mm Pitch 1X6 Pin Wafer), PS/2 keyboard and mouse port, the port can be connected to PS/2 keyboard or mouse via a dedicated cable for direct used.

Pin#	Signal Name
1	KBDATA
2	MSDATA
3	Ground
4	+5V
5	KBCLK
6	MSCLK

GPIO1:

(2.0mm Pitch 2x5 Pin Header), General-purpose input/output port, it provides a group of self-programming interfaces to customers for flexible use.

Signal Name	Pin#	Pin#	Signal Name
Ground	1	2	NC
NC	3	4	SMB_DATA_R
SMB_CLK_R	5	6	SOC-GPIO22
SOC-GPIO23	7	8	SOC-GPIO25
SOC-GPIO24	9	10	+5V

USB23:

(Double stack USB type A), Rear USB connector, it provides up to 2 USB2.0 ports, speed up to 480Mb/s.

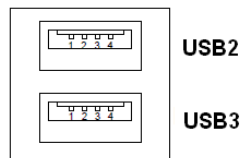

USB_23 (option) :

(2.0mm Pitch 2x5 Pin Header), front USB connector, it provides one USB port via a dedicated USB cable, speed up to 480Mb/s.

Signal Name	Pin#	Pin#	Signal Name
5V_USB23	1	2	5V_USB23
USB3_N	3	4	USB2_N
USB3_P	5	6	USB2_P
Ground	7	8	Ground
NC	9	10	Ground



Note:

Before connection, make sure that pinout of the USB Cable is in accordance with that of the said tables. Any inconformity may cause system down and even hardware damages.

JP5:

(2.0mm Pitch 2x3 Pin Header), COM3 setting jumper, pin 1~6 are used to select signal out of pin 9 of COM3 port.

JP5 Pin#	Function
Close 1-2	RI (Ring Indicator) (default)
Close 3-4	COM3 Pin9=+5V (option)

Close 5-6	COM3 Pin9=+12V (option)
-----------	-------------------------

COM3:

(Type DB9), serial port, standard DB9 serial port is provided to make a direct connection to serial devices. COM3 port is controlled by pins No.1~6 of **JP5**, select output Signal RI or 5V or 12v, for details, please refer to description of JP5.

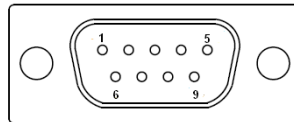

Pin#	Signal Name
1	DCD# (Data Carrier Detect)
2	RXD (Received Data)
3	TXD (Transmit Data)
4	DTR (Data Terminal Ready)
5	Ground
6	DSR (Data Set Ready)
7	RTS (Request To Send)
8	CTS (Clear To Send)
9	JP5 Setting: Pin1-2: RI (Ring Indicator) (default) Pin3-4 : 5V Standby power (option) Pin5-6: 12V Standby power (option)

JP6:

(2.0mm Pitch 2x3 Pin Header), COM_6 setting jumper, pin 1~6 are used to select signal out of pin 9 of COM_6 port.

JP6 Pin#	Function
Close 1-2	RI (Ring Indicator) (default)
Close 3-4	COM_6 Pin9=+5V (option)
Close 5-6	COM_6 Pin9=+12V (option)

COM_6:

(2.0mm Pitch 2X5 Pin Header), COM4 Port, up to one standard RS232 port are provided. They can be used directly via COM cable connection.

Signal Name	Pin#	Pin#	Signal Name
DCD	1	2	RXD

TXD	3	4	DTR
Ground	5	6	DSR
RTS	7	8	CTS
JP6 Setting: RI/5V/12V	9	10	NC

S1:

PWR BT: POWER on/off Button, They are used to connect power switch button. The two pins are disconnected under normal condition. You may short them temporarily to realize system startup & shutdown or awaken the system from sleep state.

PWR LED: POWER LED status.

S1	Model
Yes	TB-528C1U2P1
No	TB-528C1U2

44. TB-528CAN2 R0.10 (option) :

SBC-7111 Riser Card, TB-528CAN2 CN3 connect to SBC-7111 CN3 pin Header. It provides two CAN-bus Interface.

TB-528CAN2 Top:

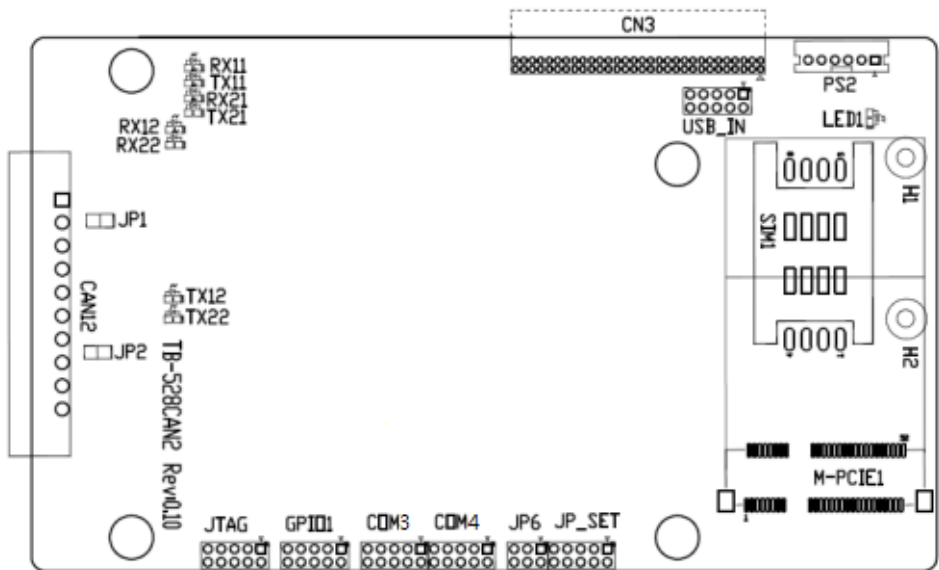

CN3:

(1.27mm Pitch 2X30 Pin Header), connect to SBC-7111 CN3 pin Header.

M-PCIE1:

(Socket 52Pin), mini PCIe socket, it is located at the top, it supports mini PCIe devices with Smbus, USB2.0, SIM and PCIe signal. MPCie card size is 30x30mm

or 30x50.95mm

Signal Name	Function support
PCIe 1X	Yes
USB2.0 (USB2)	Yes
SMBus	Yes
SIM	Yes

H1/H2:

MPCIE1 SCREW HOLES, H2 for mini PCIE card (30mmx30mm) assemble. H1 for mini PCIE card (30mmx50.95mm) assemble.

LED1:

Mini PCIe devices LED Status.

SIM1 (option) :

(SIM Socket 6 Pin), Support SIM Card devices.

PS2:

(2.0mm Pitch 1X6 Pin Wafer), PS/2 keyboard and mouse port, the port can be connected to PS/2 keyboard or mouse via a dedicated cable for direct used.

Pin#	Signal Name
1	KBDATA
2	MSDATA
3	Ground
4	+5V
5	KBCLK
6	MSCLK

USB_IN (option) :

(2.0mm Pitch 2x5 Pin Header), Front USB connector, it provides two USB port via a dedicated USB cable, speed up to 480Mb/s.

Signal Name	Pin#	Pin#	Signal Name
5V_USB23	1	2	5V_USB23
NC (USB3_N)	3	4	NC (USB2_N)
NC (USB3_P)	5	6	NC (USB2_P)
Ground	7	8	Ground
NC	9	10	Ground



Note:

Before connection, make sure that pinout of the USB Cable is in accordance with that of the said tables. Any inconformity may cause system down and even hardware damages.

JP_SET (option) :

(2.0mm Pitch 2x5 Pin Header).

Signal Name	Pin#	Pin#	Signal Name
3P3V_S5_USB	1	2	3P3V_S5
3P3V_S5_USB	3	4	3P3V_S5
3P3V_S5_USB	5	6	3P3V_S5
PSON_ATX	7	8	Ground
PSON_ATX	9	10	Ground

JP6:

(2.0mm Pitch 2x3 Pin Header), COM4 setting jumper, pin 1~6 are used to select signal out of pin 9 of COM4 port.

JP6 Pin#	Function
Close 1-2	RI (Ring Indicator) (default)
Close 3-4	COM4 Pin9=+5V (option)
Close 5-6	COM4 Pin9=+12V (option)

COM4:

(2.0mm Pitch 2X5 Pin Header), COM4 Port, up to one standard RS232 port are provided. They can be used directly via COM cable connection.

Signal Name	Pin#	Pin#	Signal Name
DCD	1	2	RXD
TXD	3	4	DTR
Ground	5	6	DSR
RTS	7	8	CTS
JP6 Setting: RI/5V/12V	9	10	NC

COM3:

(2.0mm Pitch 2X5 Pin Header), COM3 Port, up to one standard RS232 port are provided. They can be used directly via COM cable connection.

Signal Name	Pin#	Pin#	Signal Name
DCD	1	2	RXD
TXD	3	4	DTR
Ground	5	6	DSR
RTS	7	8	CTS
RI	9	10	NC

GPIO1:

(2.0mm Pitch 2x5 Pin Header), General-purpose input/output port, it provides a group of self-programming interfaces to customers for flexible use.

Signal Name	Pin#	Pin#	Signal Name
Ground	1	2	NC
NC	3	4	SMB_DATA_R
SMB_CLK_R	5	6	SOC-GPIO22
SOC-GPIO23	7	8	SOC-GPIO25
SOC-GPIO24	9	10	+5V

JTAG:

(2.0mm Pitch 2x5 Pin Header), Reserve.

JP1:

(2.0mm Pitch 1x2 Pin Header), Reserve.

JP2:

(2.0mm Pitch 1x2 Pin Header), Reserve.

CAN1/CAN2:

(3.5mm Pitch 1x10 Pin connector), it provides two CAN-bus Interface.

Pin#	Channel	Signal Name	Function
1	CAN2	CANL2	CAN bus Signal L
2		R2-	Terminal resistor R-(internally connected to CANL2)
3		FG	Shield cable (FG)
4		R2+	Terminal resistor R+(internally connected to CANH2)
5		CANH2	CAN bus Signal H
6		CANL1	CAN bus Signal L

7	CAN1	R1-	Terminal resistor R-(internally connected to CANL1)
8		FG	Shield cable (FG)
9		R1+	Terminal resistor R+(internally connected to CANH1)
10		CANH1	CAN bus Signal H

【 See TB-528AN2 Manual 】

45. TB-528U2 (option) :

SBC-7111 Riser Card, TB-528U2 CN3 connect to SBC-7111 CN3 pin Header.

TB-528U2 Top:

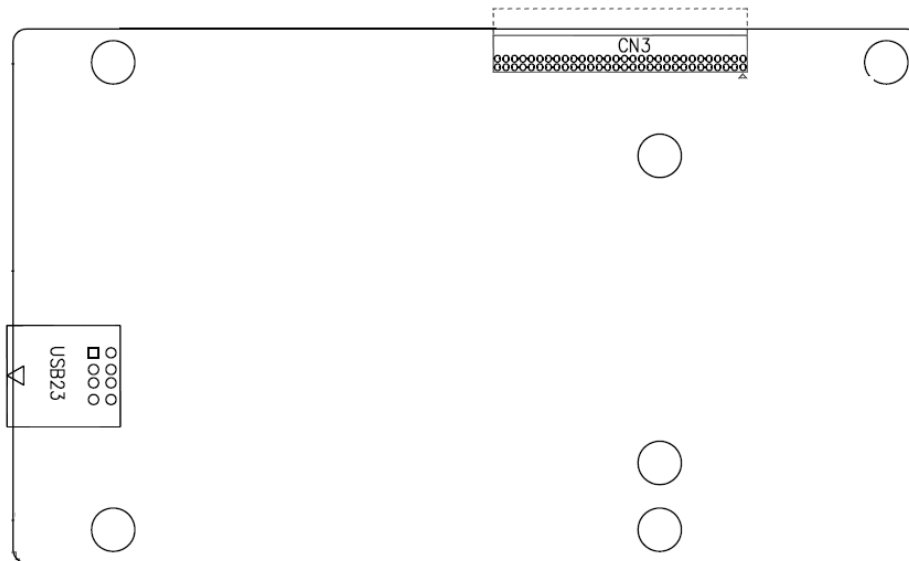

CN3:

(1.27mm Pitch 2X30 Pin Header), connect to SBC-7111 CN3 pin Header.

USB23:

(Double stack USB type A), Rear USB connector, it provides up to 2 USB2.0 ports, speed up to 480Mb/s.

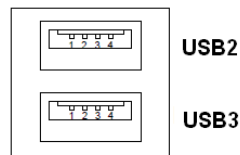

Chapter 3

BIOS Setup

3.1 Operations after POST Screen

After CMOS discharge or BIOS flashing operation, press [Delete] key to enter CMOS Setup.



Version 2.17.1246. Copyright (C) 2014 American Megatrends, Inc.
BIOS Date: 12/18/2014 09:54:21 Ver: 7111i107
Press or <ESC> to enter setup

99

After optimizing and exiting CMOS Setup, the POST screen displayed for the first time is as follows and includes basic information on BIOS, CPU, memory, and storage devices.

3.2 BIOS Setup Utility

Press [Delete] key to enter BIOS Setup utility during POST, and then a main menu containing system summary information will appear.

3.3 Main Settings

Aptio Setup Utility – Copyright (C) 2014 American Megatrends, Inc.					
Main	Advanced	Chipset	Security	Boot	Save & Exit
BIOS Information					Choose the system default Language
BIOS Vendor	American Megatrends				
Core Version	5.010				
Compliance	UEFI 2.4; PI 1.3				
Project Version	7111i 1.07 x64				
Build Date and Time	12/18/2014 09:54:21				
CPU Configuration					
Microcode Patch	901				
BayTrail SoC	DO Stepping				
KSC Information					
KSC Version	N/A				
Memory Information					
Total Memory	4096 MB (DDR3L)				
GOP Information					
Intel (R) GOP Driver	[N/A]				
TXE Information					→←: Select Screen
Sec RC Version	00.05.00.00		↑↓ : Select Item		
TXE FW Version	01.01.00.1089		Enter: Select		
System Language					+/- : Change Opt.
	[English]		F1 : General Help		
System Date					F2: Previous Values
	[Sun 01/01/2012]		F3:Optimized Defaults		
System Time					F4:Save and Exit
	[00:00:10]		ESC Exit		

System Time:

Set the system time, the time format is:

Hour : 0 to 23

Minute : 0 to 59

Second : 0 to 59

System Date:

Set the system date, the date format is:

Day: Note that the 'Day' automatically changes when you set the date.

Month: 01 to 12

Date: 01 to 31

Year: 1998 to 2099

3.4 Advanced Settings

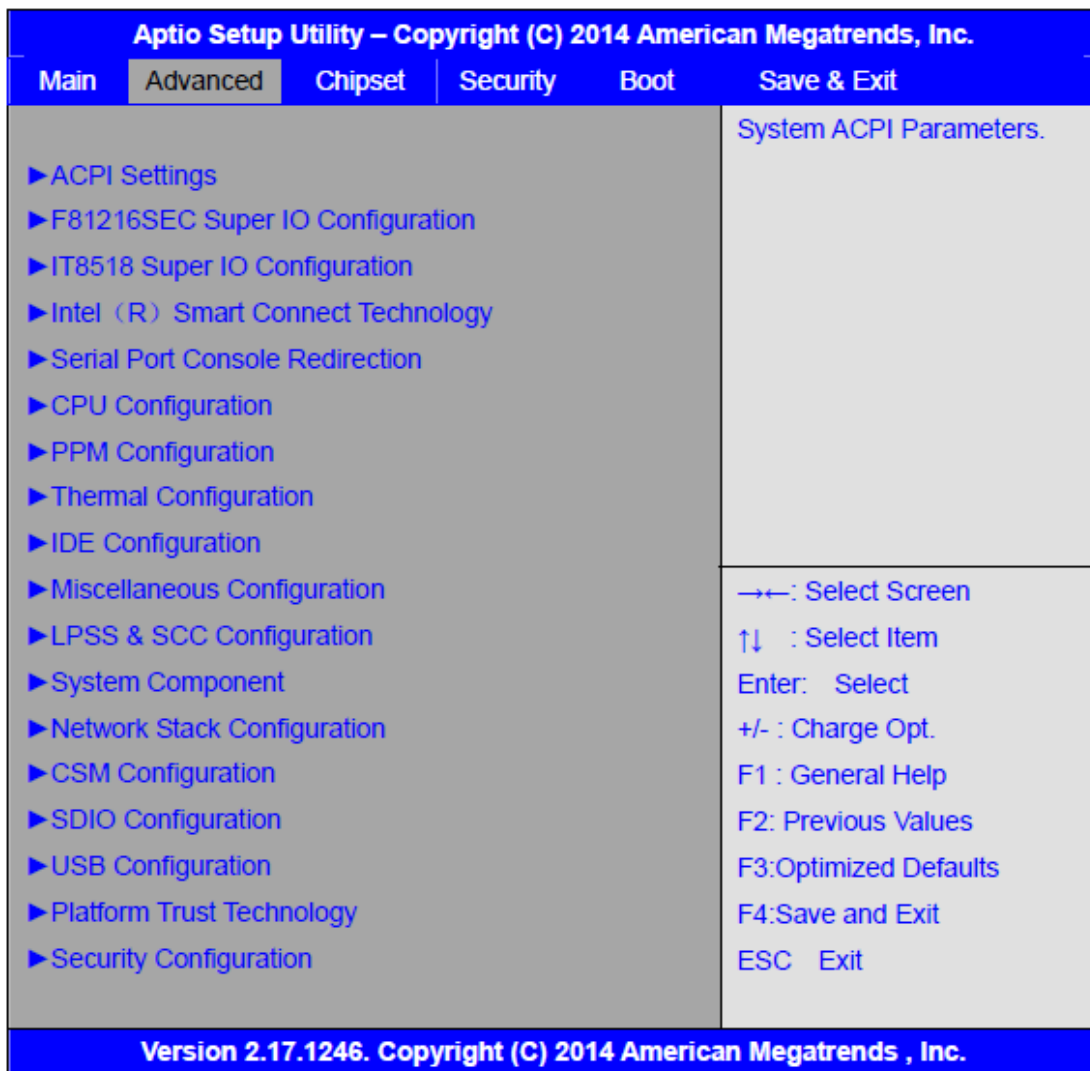

3.4.1 ACPI Settings

Enable ACPI Auto Conf:

[Disabled]

[Enabled]

Enable Hibernation:

[Enabled]

[Disabled]

ACPI Sleep State:

[S3 (Suspend to RAM)]

[Suspend Disabled]

Lock Legacy Resources:

[Disabled]

[Enabled]

3.4.2 F81216SEC Super IO Configuration

Super IO chip F81216SEC

Serial Port 1 Configuration

UART1 Mode Selection:

[RS-232]

[RS-485]

[RS-422]

Serial Port 2 Configuration

Change Settings [Auto]

Serial Port 3 Configuration

Change Settings [Auto]

Serial Port 4 Configuration

Change Settings [Auto]

3.4.3 IT8518 Super IO Configuration

Super IO chip IT8518/IT8519

Serial Port 1 Configuration

Backlight PWM Controller (COM5) :

[RS-485]

[RS-422]

Serial Port 2 Configuration (COM6)

Change Settings [Auto]

3.4.4 Intel (R) Smart Connect Technology

ISCT Support

[Disabled]

[Enabled]

3.4.5 Serial Port Console Redirection

COM0

Console Redirection

[Disabled]

[Enabled]

Console Redirection Settings

Legacy Console Redirection

Legacy Console Redirection settings

Serial Port for Out-of-Band Management/

Windows Emergency Management Services (EMS)

Console Redirection

[Disabled]

[Enabled]

Console Redirection Settings

3.4.6 CPU Configuration

Socket 0 CPU Information

Intel(R) Atom(TM) CPU E3845 @ 1.91GHz

CPU Signature	30679
Microcode Patch	901
Max CPU Speed	1910 MHz
Mix CPU Speed	500 MHz
Processor Cores	4
Intel HT Technology	Not Supported
Intel HT-X Technology	Supported
L1 Data Cache	24KB x 4
L1 Code Cache	32KB x 4
L2 Cache	1024KB x 2
L2 Cache	Not Present

CPU Thermal configuration

CPU Speed	1918 MHz
64-bit	Supported
Hyper-Threading:	
	[Enabled]
	[Disabled]

Limit CPUID Maximum:	[Disabled] [Enabled]
Execute Disable Bit:	[Enabled] [Disabled]
Intel Virtualization Technology:	[Enabled] [Disabled]
Power Technology	[Energy Efficient] [Disabled] [Custom]

3.4.7 PPM Configuration

CPU C State Report	[Enabled] [Disabled]
Max CPU C-state	[C7] [C6] [C1]
SOix	[Disabled] [Enabled]

3.4.8 Thermal Configuration Parameters

3.4.9 IDE Configuration

Serial-ATA(SATA)	[Enabled] [Disabled]
SATA Test Mode	[Disabled] [Enabled]
SATA Speed Support	[Gen2] [Gen1]

SATA ODD Port	[No ODD] [Port0 ODD] [Port1 ODD] [Disabled]
SATA Mode	[AHCI Mode] [IDE Mode]
Serial-ATA Port 0	[Enabled] [Disabled]
SATA Port0 Hotplug	[Disabled] [Enabled]
Serial-ATA Port 1	[Enabled] [Disabled]
SATA Port1 Hotplug	[Disabled] [Enabled]
SATA Port0	Not Present
SATA Port1	Not Present

3.4.10 Miscellaneous Configuration

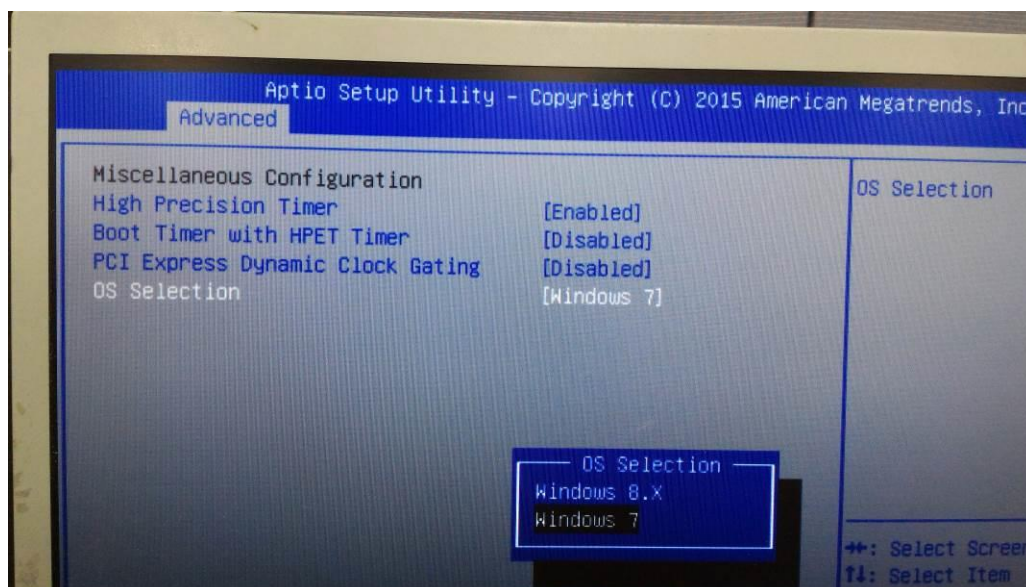

High Precision Timer	[Enabled]
	[Disabled]
Boot Timer with HPET Timer	[Disabled]
	[Enabled]
PCI Express Dynamic Clock Gating	[Disabled]
	[Enabled]

OS Selection

Use the **OS Selection** option to select an operating system for the system.



Note:

Users must go to this item to select the OS mode before installing corresponding OS driver, otherwise problems will occur when installing the driver.

3.4.11 LPSS & SCC Configuration

LPSS & SCC Configuration	[ACPI Mode]
SCC Configuration	
SCC eMMC Support	[eMMC AUTO MODE]
SCC eMMC 4.5 DDR50 Support	[Enabled]
SCC eMMC 4.5 HS200 Support	[Disabled]
eMMC Secure Erase	[Disabled]
SCC SDIO Support	[Enabled]
SCC SD Card Support	[Enabled]
SDR25 Support for SDCard	[Disabled]
SDR50 Support for SDCard	[Enabled]
MIPI HSI Support	[Disabled]
LPSS Configuration	
LPSS DMA #1 Support	[Enabled]
LPSS DMA #2 Support	[Enabled]
LPSS I2C #1 Support	[Enabled]
LPSS I2C #2 Support	[Enabled]
LPSS I2C #3 Support	[Enabled]
LPSS I2C #4 Support	[Enabled]

LPSS I2C #5 Support	[Enabled]
LPSS I2C #6 Support	[Enabled]
LPSS I2C #7 Support	[Enabled]
NFC	[Disabled]
Touch Pad	[Disabled]
I2C touch Device Address	
LPSS HSUART #1 Support	[Disabled]
LPSS HSUART #2 Support	[Disabled]
LPSS PWM #1 Support	[Enabled]
LPSS PWM #2 Support	[Enabled]
LPSS SPI Support	[Enabled]

3.4.12 System Component

3.4.13 Network Stack Configuration

Network Stack	[Disabled]
---------------	------------

3.4.14 CSM Configuration

CSM Support	[Enabled]
CSM16 Module Version	07.76
GateA20 Active	[Upon Request] [Always]
Option ROM Messages	[Force BIOS] [Keep Current]
Boot option filter	[UEFI and Legacy] [Legacy only] [UEFI only]
Network	[UEFI] [Do not launch] [Legacy]
Storage	[UEFI] [Do not launch] [Legacy]
Video	[Legacy] [UEFI]

	[Do not launch]
Other PCI devices	
	[UEFI]
	[Do not launch]
	[Legacy]

3.4.15 SDIO Configuration

3.4.16 USB Configuration

USB Configuration	
USB Module Version 8.11.02	
USB Devices:	
1 keyboard, 1 Mouse, 2 Hubs	
Legacy USB Support:	
	[Enabled]
	[Disabled]
XHCI Hand-off:	
	[Enabled]
	[Disabled]
EHCI Hand-off:	
	[Disabled]
	[Enabled]
USB Mass Storage Driver Support	
	[Enabled]
	[Disabled]
USB hardware delays and time-outs:	
USB transfer time-out:	
	[20 sec]
	[10 sec]
	[5 sec]
	[1 sec]
Device reset time-out:	
	[20 sec]
	[10 sec]
	[30 sec]
	[40 sec]
Device power-up delay	
	[Auto]
	[Manual]

3.4.17 Platform Trust Technology

3.4.18 Security Configuration

3.5 Chipset Settings

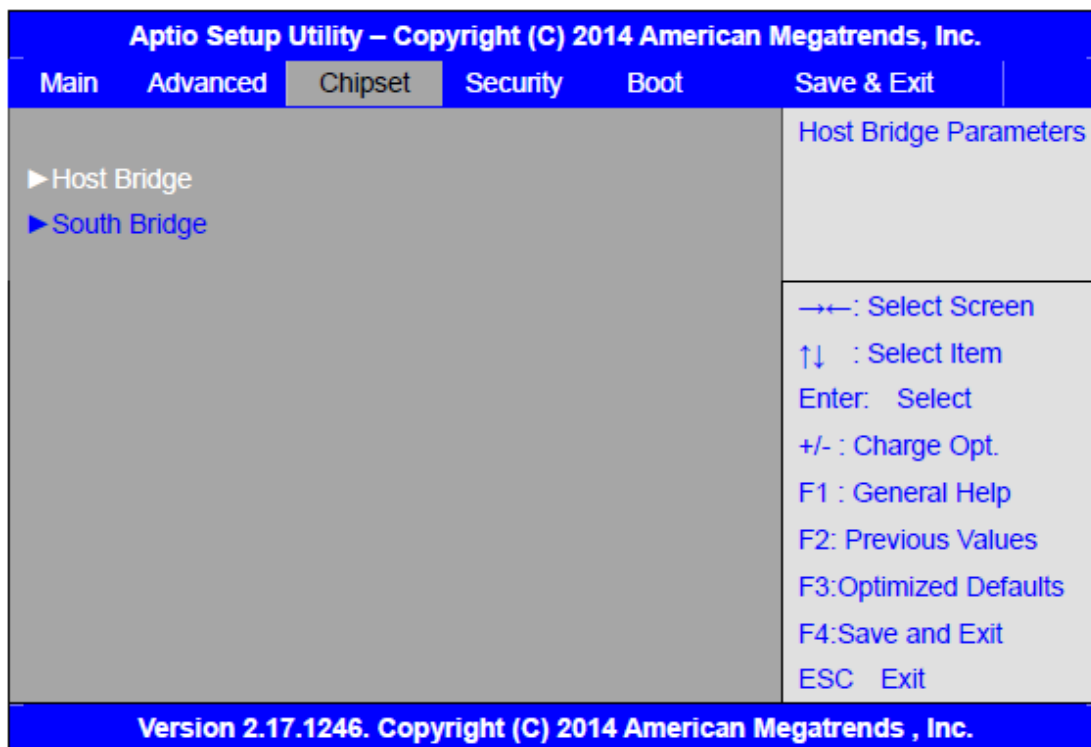

3.5.1 Host Bridge

▶ Intel IGD Configuration

▶ IGD – LCD Control

Force Lid Status	[On] [Off]
BIA	[Auto]
ALS Support	[Disabled]
IGD Flat Panel	[Auto]
Pannel Scaling	[Auto]

▶ Memory Frequency and Timing

▶ Graphics Power Management Control

Memory Information	
Total Memory	4096 MB(DDR3L)
Memory Slot0	4096 MB(DDR3L)
DIMM#1	Not Present

Max TOLUD

[Dynamic]

[2GB]

[2.25GB]

[2.5GB]

[2.75GB]

[3GB]

3.5.2 South Bridge

▶ Azalia HD Audio

▶ USB Configuration

USB OTG Support [Disabled]

USB VBUS [On]

XHCI Mode [Smart Auto]

USB2 Link Power Management [Enabled]

USB 2.0(EHCI) Support [Enabled]

USB EHCI debug [Disabled]

USB Per Port Control [Enabled]

USB Port 0 [Enabled]

USB Port 1 [Enabled]

USB Port 2 [Enabled]

USB Port 3 [Enabled]

3.6 Security Settings

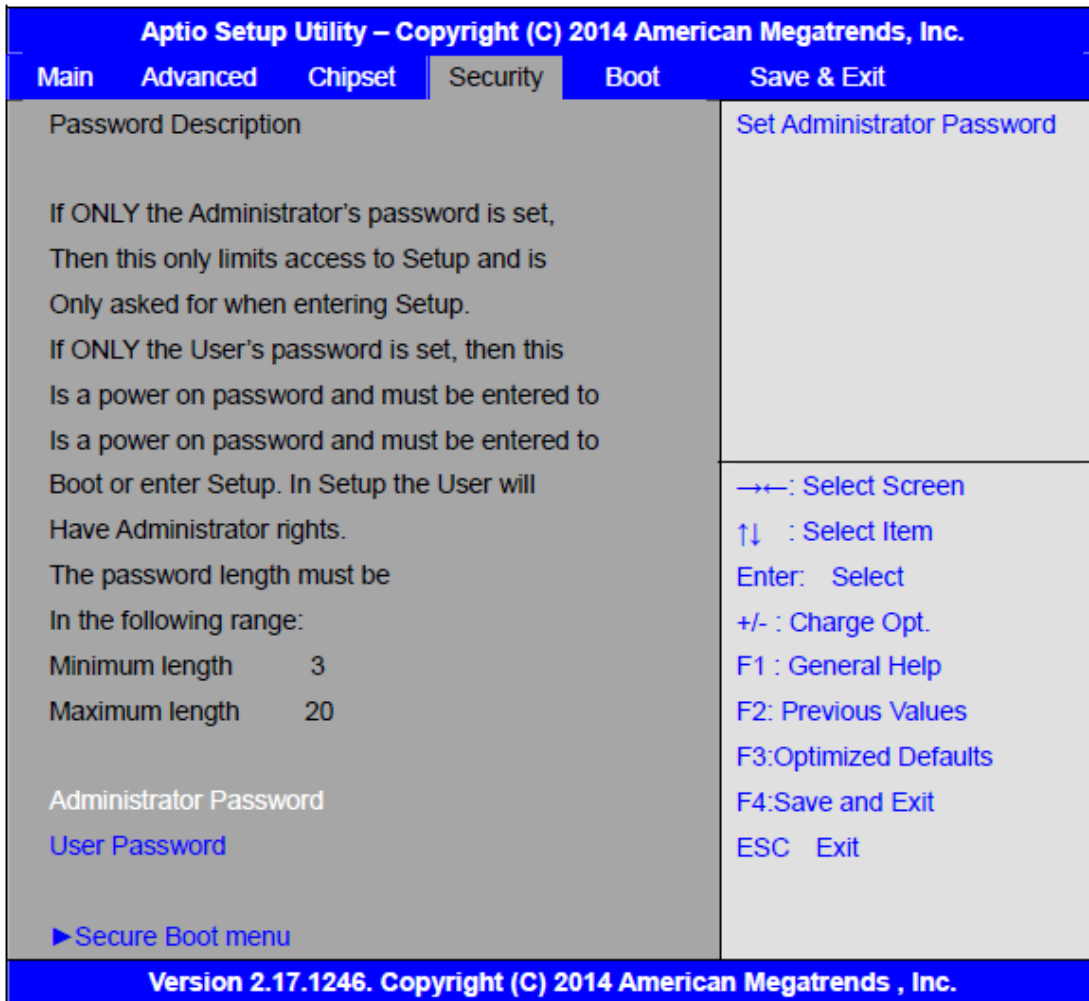

3.6.1 Administrator Password



3.6.2 User Password



Type the password with up to 20 characters and then press **<Enter>** key. This will clear all previously typed CMOS passwords. You will be requested to confirm the password. Type the password again and press **<Enter>** key. You may press **<Esc>** key to abandon password entry operation.

To clear the password, just press **<Enter>** key when password input window pops up. A confirmation message will be shown on the screen as to whether the password

will be disabled. You will have direct access to BIOS setup without typing any password after system reboot once the password is disabled.

Once the password feature is used, you will be requested to type the password each time you enter BIOS setup. This will prevent unauthorized persons from changing your system configurations.

Also, the feature is capable of requesting users to enter the password prior to system boot to control unauthorized access to your computer. Users may enable the feature in Security Option of Advanced BIOS Features. If Security Option is set to System, you will be requested to enter the password before system boot and when entering BIOS setup; if Security Option is set to Setup, you will be requested for password for entering BIOS setup.

3.7 Boot Settings

Aptio Setup Utility – Copyright (C) 2014 American Megatrends, Inc.					
Main	Advanced	Chipset	Security	Boot	Save & Exit
Boot Configuration					Number of seconds to Wait for Setup Activation key.
Setup Prompt Timeout		1		65535(0xFFFF)means indefinite waiting.	
Bootup Numlock State		[On]			
Quiet Boot		[Disabled]			
Fast Boot		[Enabled]			
Boot Option Priorities					→←: Select Screen
Boot Option #1		[UEFI:Built-in EFI...]		↑↓ : Select Item	
					Enter: Select
					+/- : Change Opt.
					F1 : General Help
					F2: Previous Values
					F3:Optimized Defaults
					F4:Save and Exit
					ESC Exit
Version 2.17.1246. Copyright (C) 2014 American Megatrends , Inc.					

Setup Prompt Timeout	[1]
Bootup Numlock State	[On]
Quiet Boot	[off]
	[Disabled]

	[Enabled]
Fast Boot	
	[Disabled]
	[Enabled]
Boot Option Priorities	
Boot Option #1	
	Sets the system boot order
Hard Drive BBS Priorities	[SATA PM:*** ...]
	Boot Option #1
	SATA PM:***...

	Disabled

3.8 Save & Exit Settings

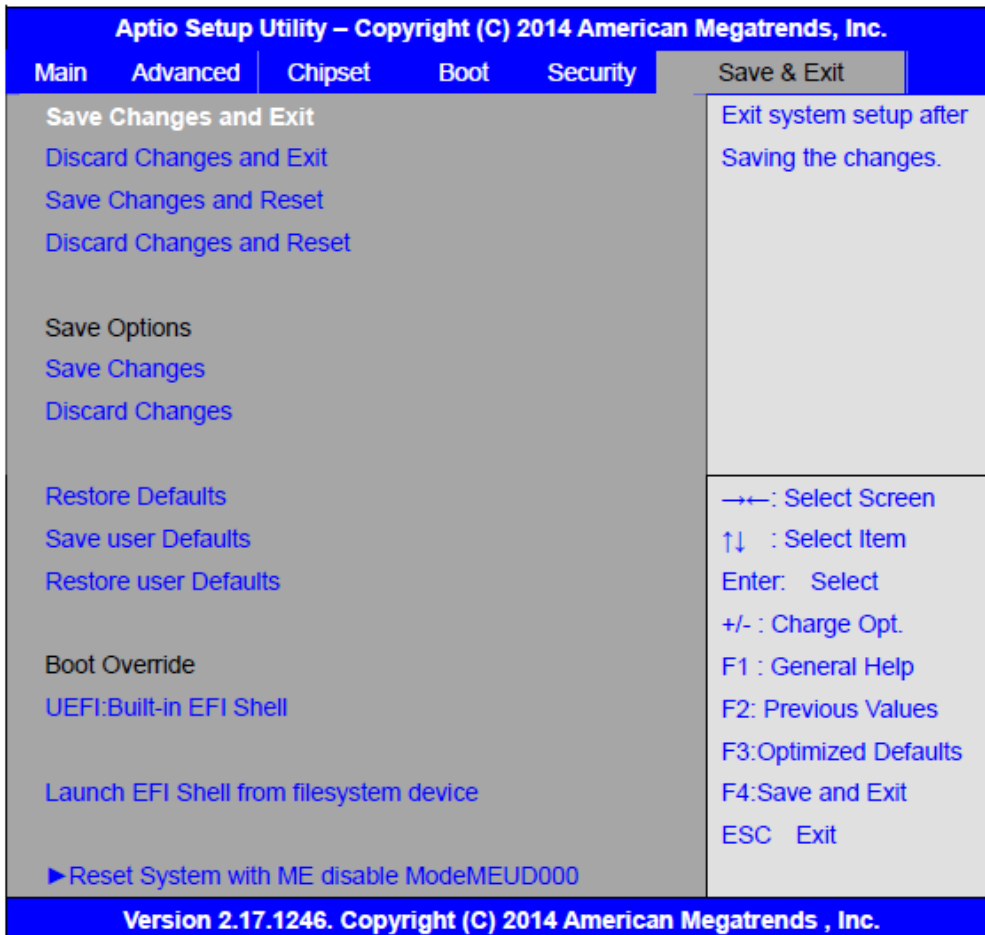

Save Changes and Exit

Save & Exit Setup save Configuration and exit ?

[Yes]

[No]

Discard Changes and Ext
 Exit Without Saving Quit without saving?
 [Yes]
 [No]

Save Changes and Reset
 Save & reset Save Configuration and reset?
 [Yes]
 [No]

Discard Changes and Reset
 Reset Without Saving Reset without saving?
 [Yes]
 [No]

Save Changes
 Save Setup Values Save configuration?
 [Yes]
 [No]

Discard Changes
 Load Previous Values Load Previous Values?
 [Yes]
 [No]

Restore Defaults
 Load Optimized Defaults Load optimized Defaults?
 [Yes]
 [No]

Save user Defaults
 Save Values as User Defaults Save configuration?
 [Yes]
 [No]

Restore user Defaults
 Restore User Defaults Restore User Defaults?
 [Yes]
 [No]

Launch EFI Shell from filesystem device
 WARNING Not Found
 [ok]

Reset System with ME disable ModeMEUD000
 ME will runs into the temporary disable mode, Ignore if ME Ignition
 FWMEUD001.

Chapter 4 Installation of Drivers

This chapter describes the installation procedures for software and drivers under the windows 7. The software and drivers are included with the motherboard. The contents include **Intel chipset driver, VGA driver, LAN drivers, Audio driver, USB 3.0 Driver** Installation instructions are given below.

Important Note:

After installing your Windows operating system, you must install first the Intel Chipset Software Installation Utility before proceeding with the installation of drivers.



4.1 Intel(R) AtomTM SoC Chipset

To install the Intel chipset driver, please follow the steps below.

Step 1. Select **Intel (R) Atom™ SoC Chipset** from the list



Step 2. Click **Next** to setup program.



Step 3. Read the license agreement. Click **Yes** to accept all of the terms of the license agreement.



Step 4. Click **Next** to continue.

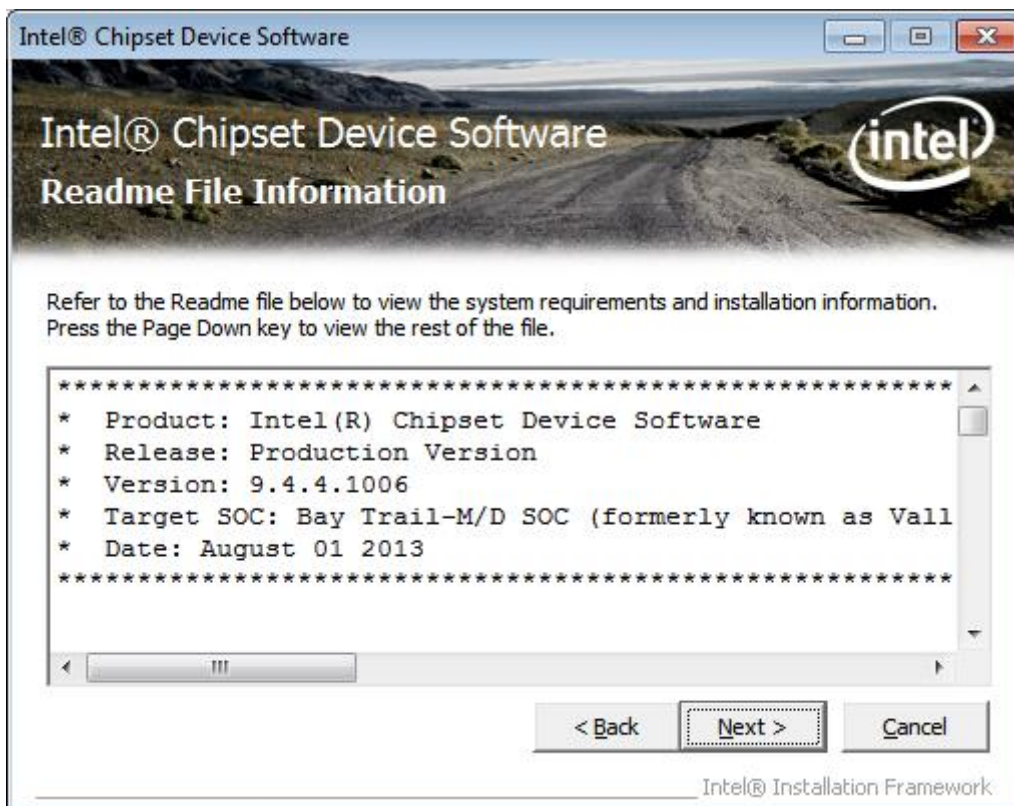

Step 5. Click **Next**.

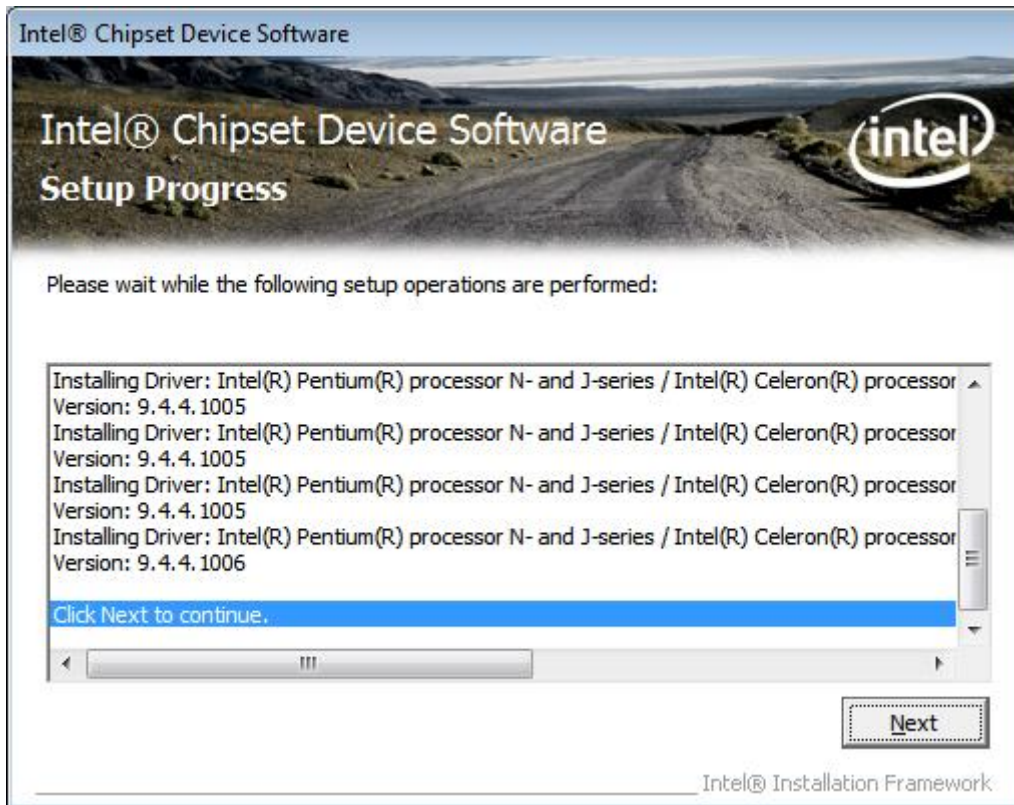

Step 6. Select **Yes, I want to restart this computer now.** Click **Finish**, then remove any installation media from the drives.



4.2 Intel(R) VGA Chipset

To install the VGA drivers, follow the steps below to proceed with the installation.

Step 1. Select Intel(R) VGA Chipset



Step 2. Click **Automatically run WinSAT and enable the Windows Aero desktop theme (if supported)**. Click **Next**.

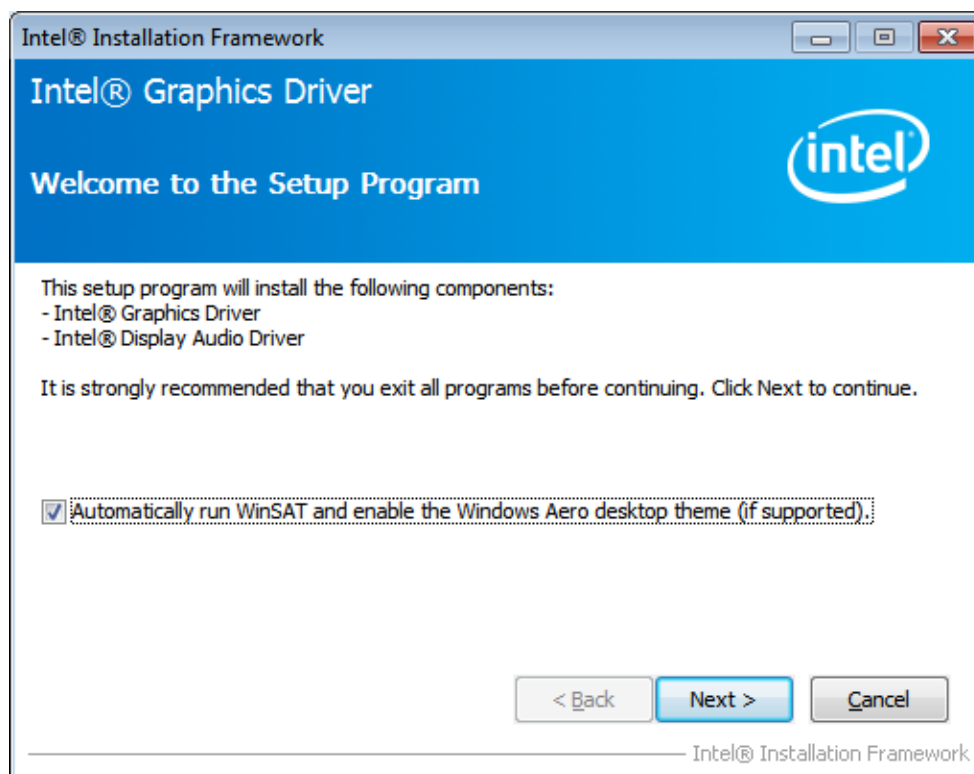

Step 3. Read license agreement. Click **Yes**.



Step 4. Click **Next**.

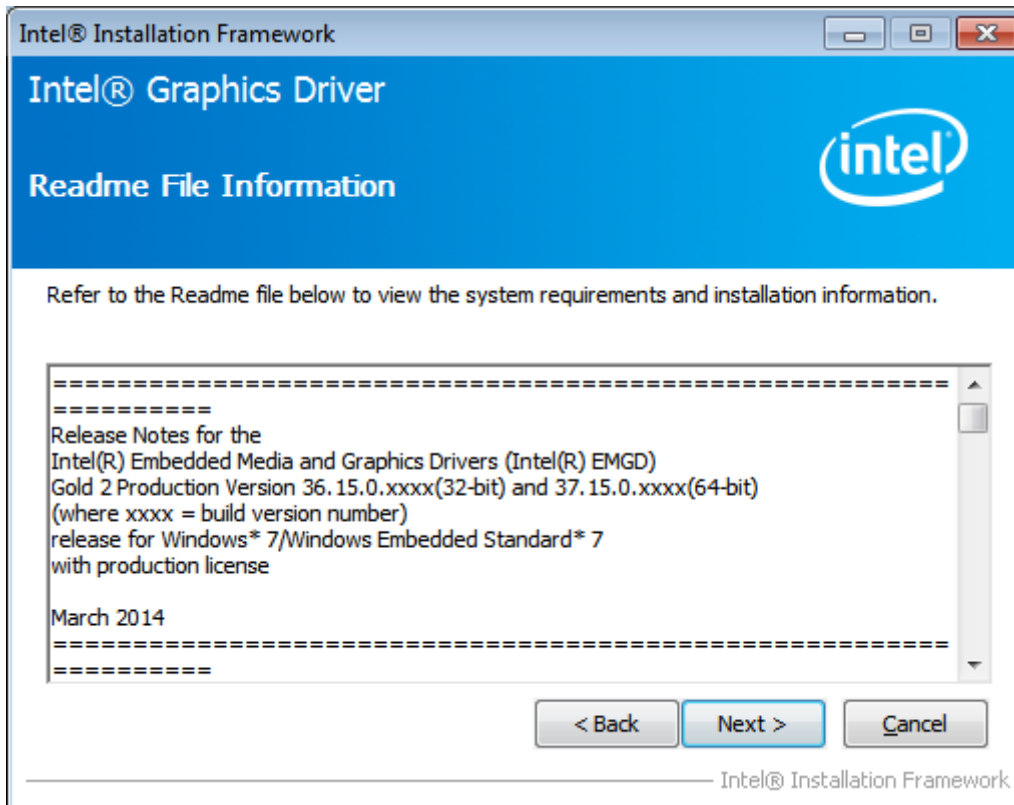

Step 5. Click Install.

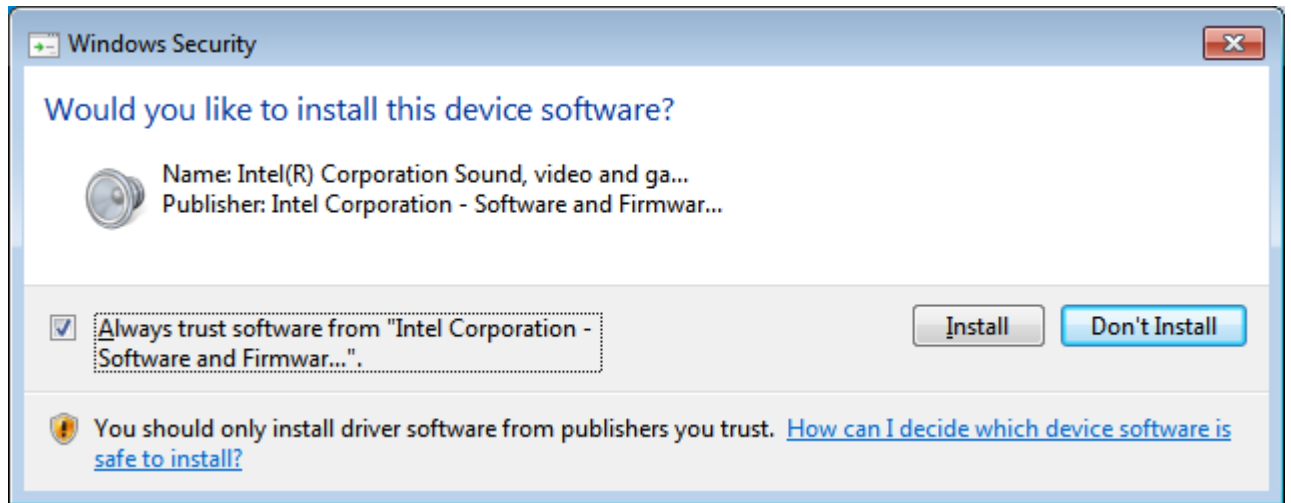

Step 6. Click Install.

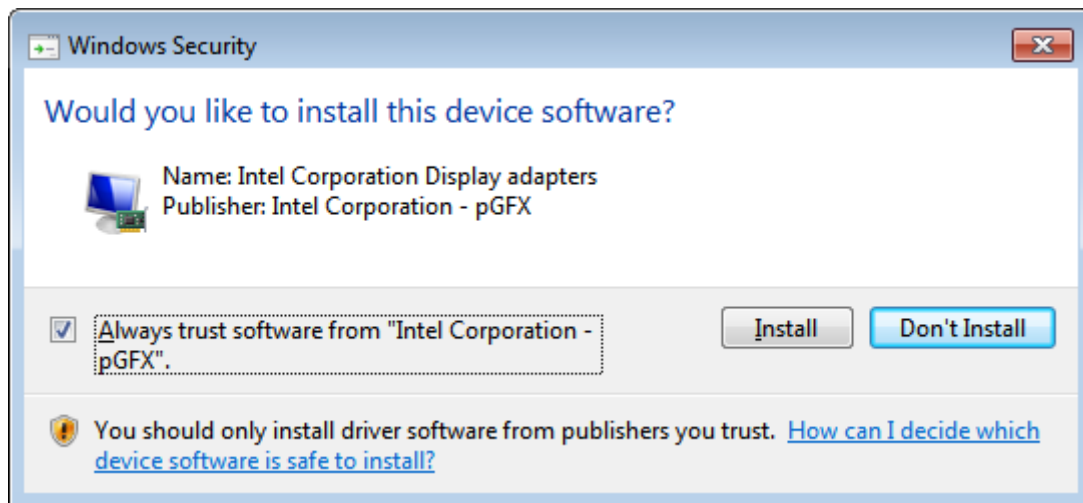

Step 7. Click Next.

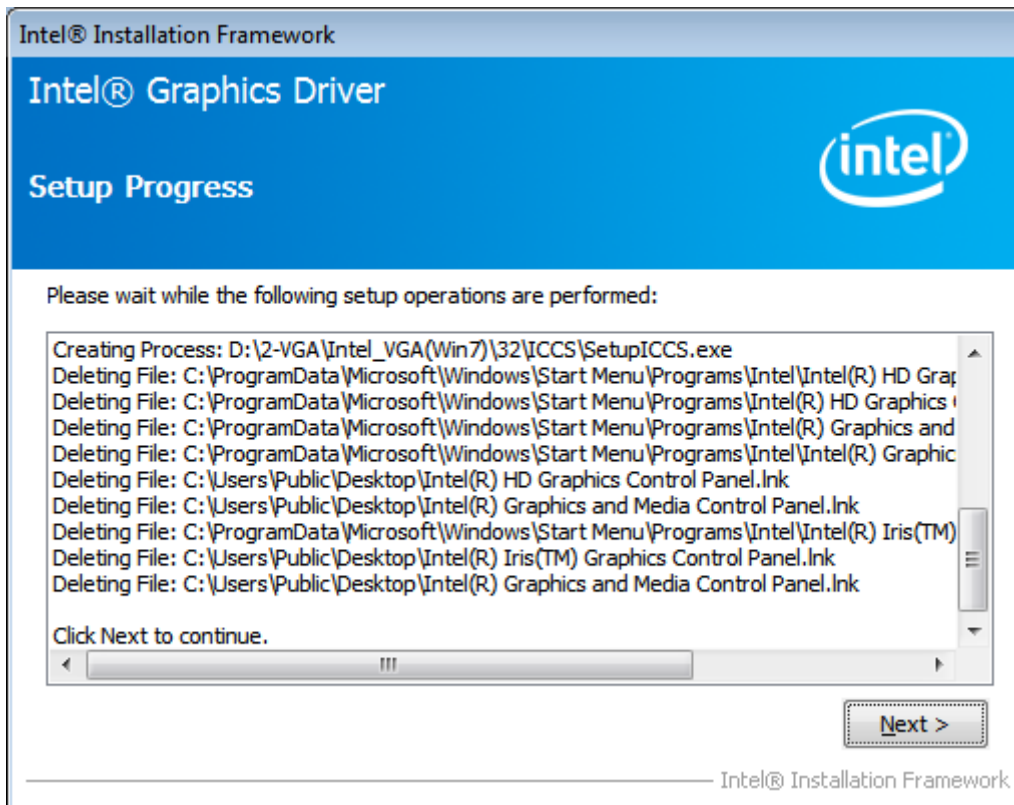

Step 8. Click Yes, I want to restart this computer now. Then click Finish.

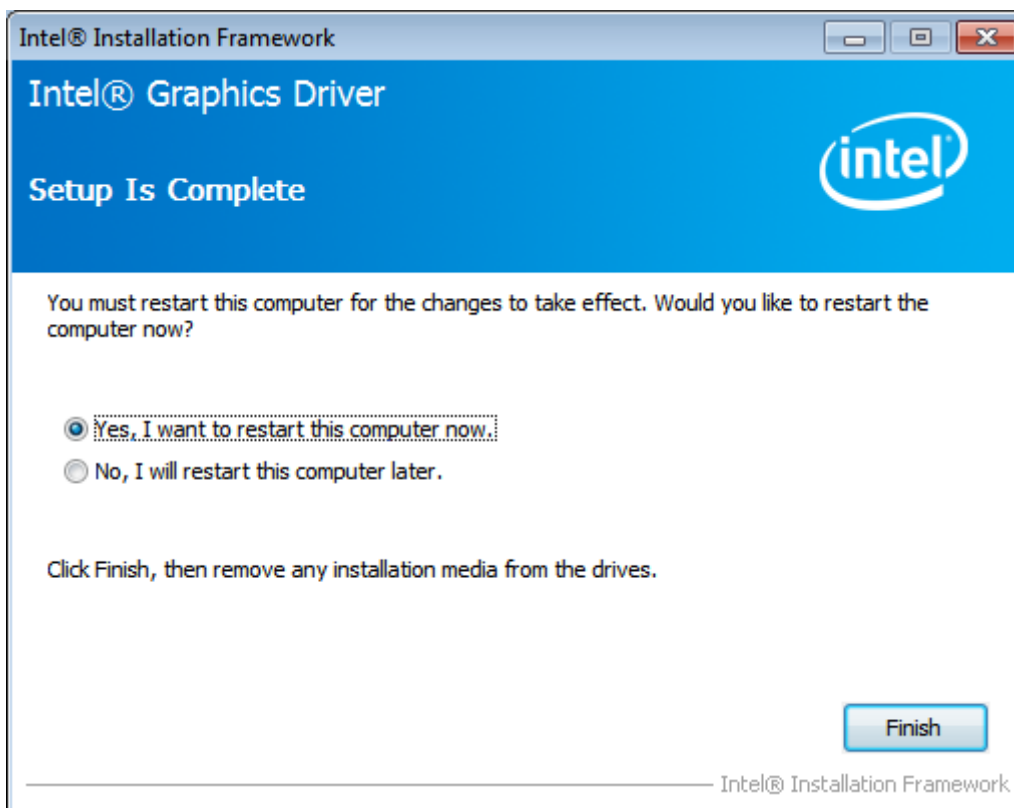

4.3 Intel(R) LAN Driver

To install the Intel (R) LAN driver, please follow the steps below.

Step 1. Select **Intel(R) 82574L LAN Driver** from the list.



Step 2. . Click **Next**.

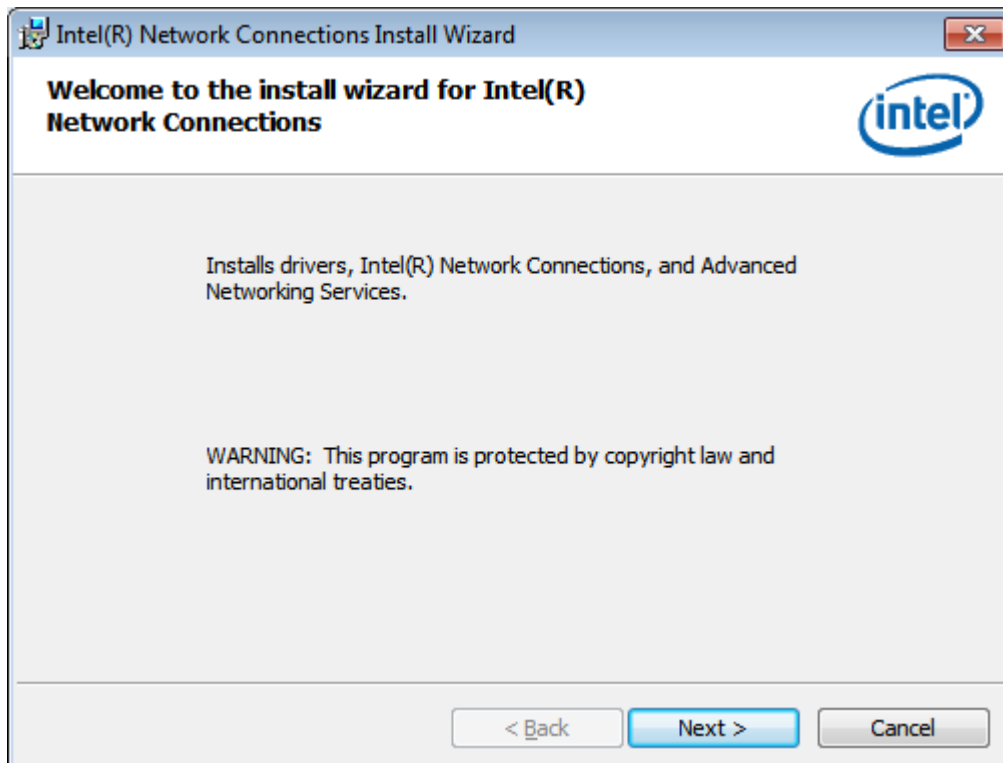

Step 3. Read license agreement. Click **I accept the terms in the license agreement**.
Click **Next**.

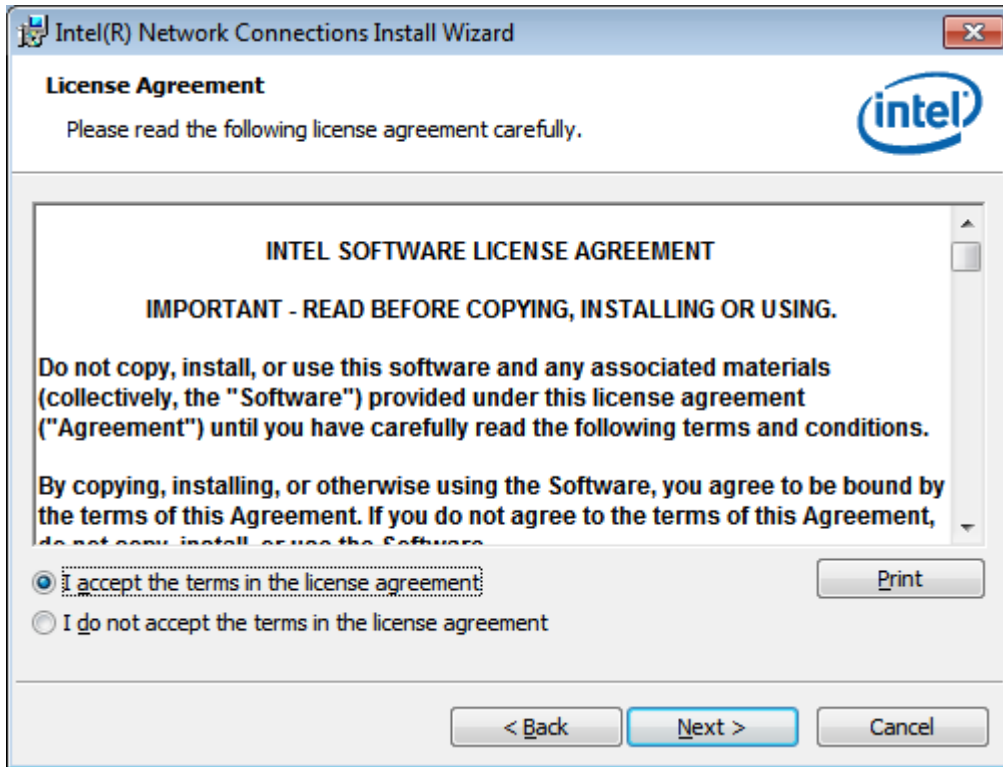

Step 4. Click **Next** to continue.

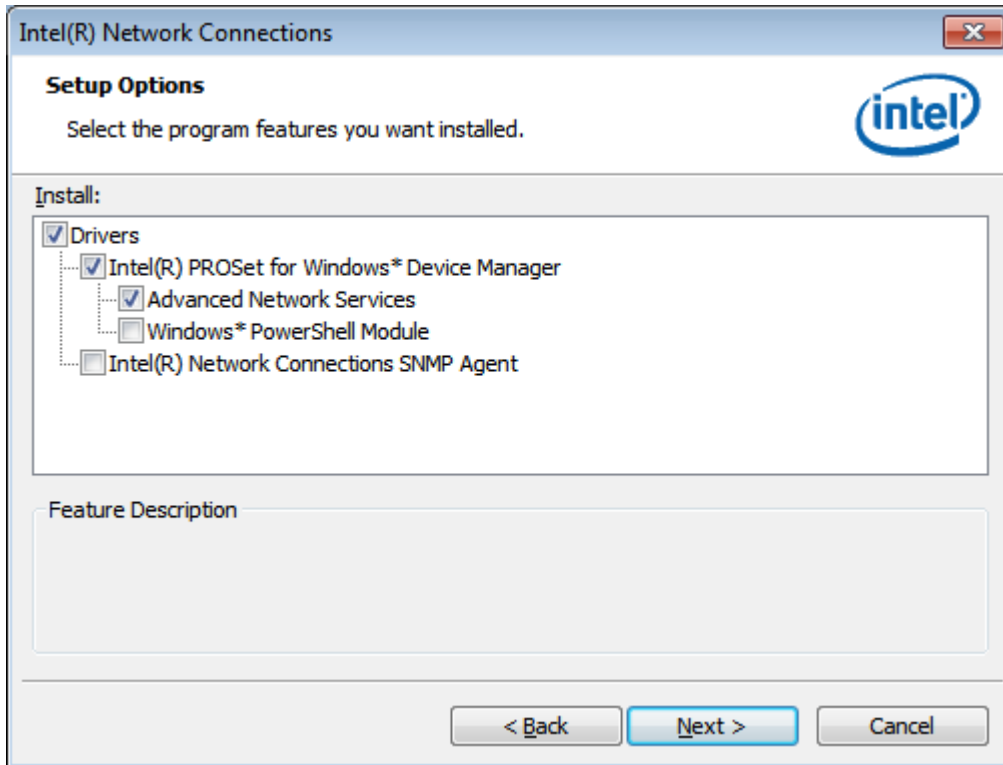

Step 5. Click **Install** to begin the installation.

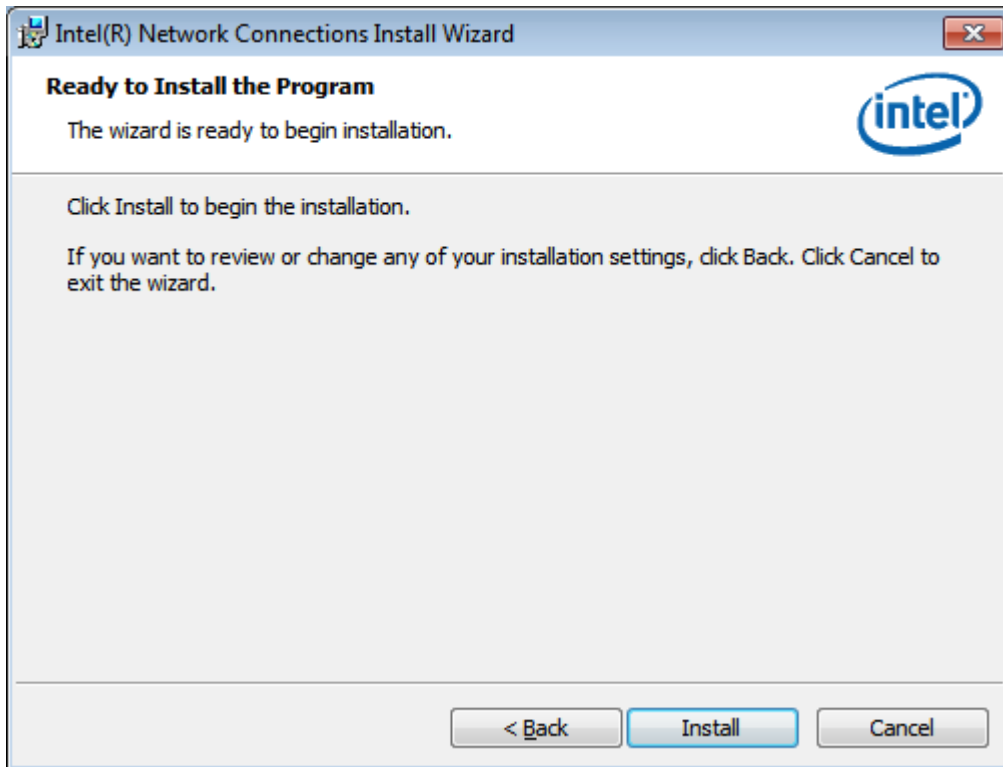

Step 6. Click **Finish** to exit the wizard.

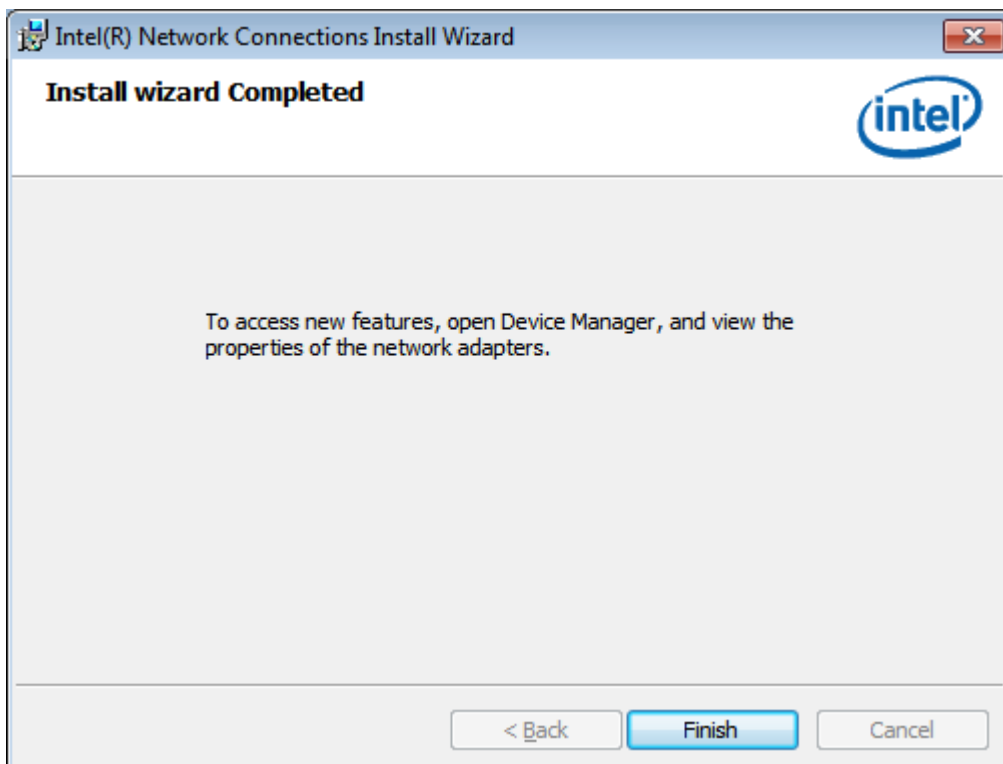

4.4 Realtek ALC662 HD Audio Driver Installation

To install the Realtek ALC662 HD Audio Driver, please follow the steps below.

Step 1. Select **Realtek AL662 HD Audio Driver** from the list



Step 2. Click **Next** to continue.

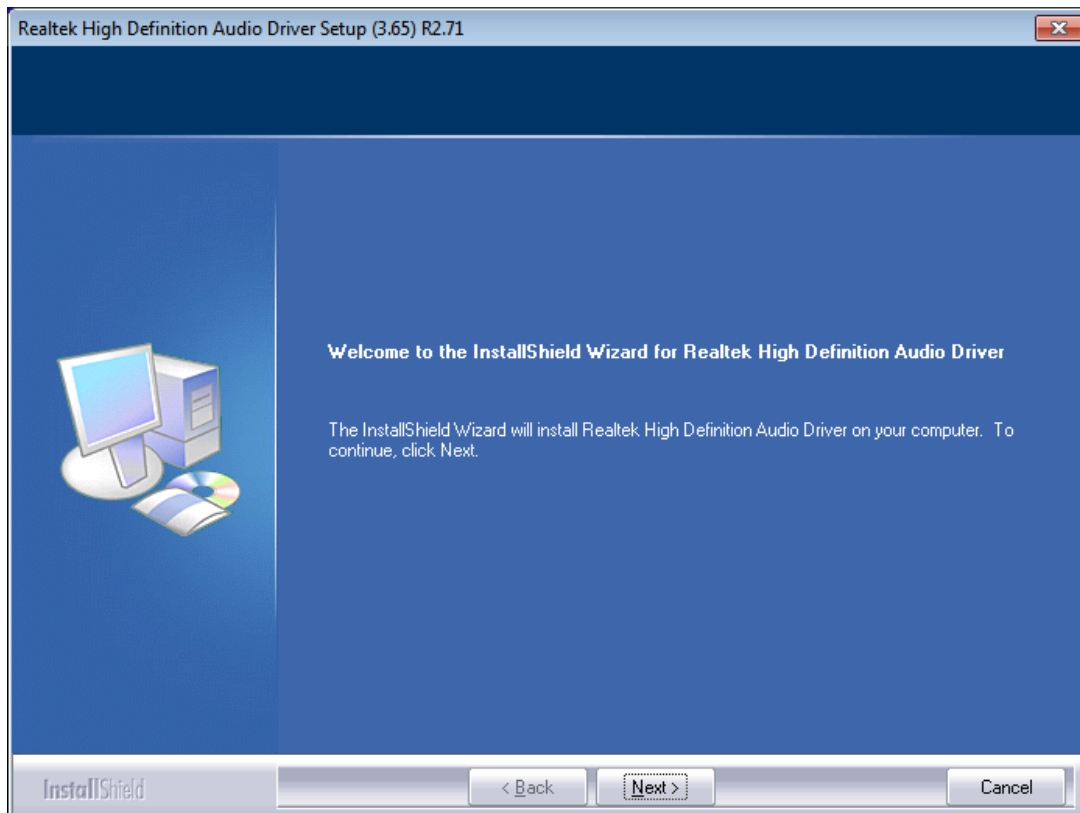

Step 3. Click **Yes, I want to restart my computer now.** Click **Finish** to complete the installation.

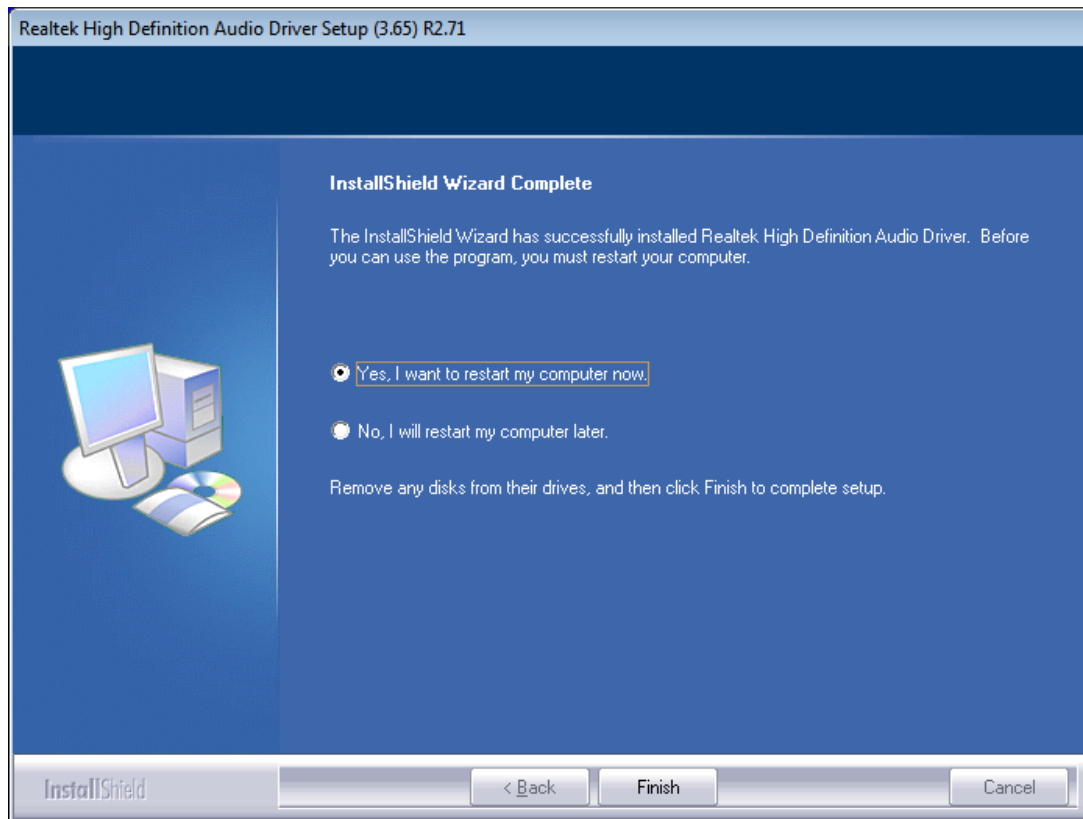

4.5 USB 3.0 Driver

To install the USB 3.0 Driver, please follow the steps below.

Step 1. Select **USB 3.0 Driver** from the list



Step 2. Click **Next** to continue.

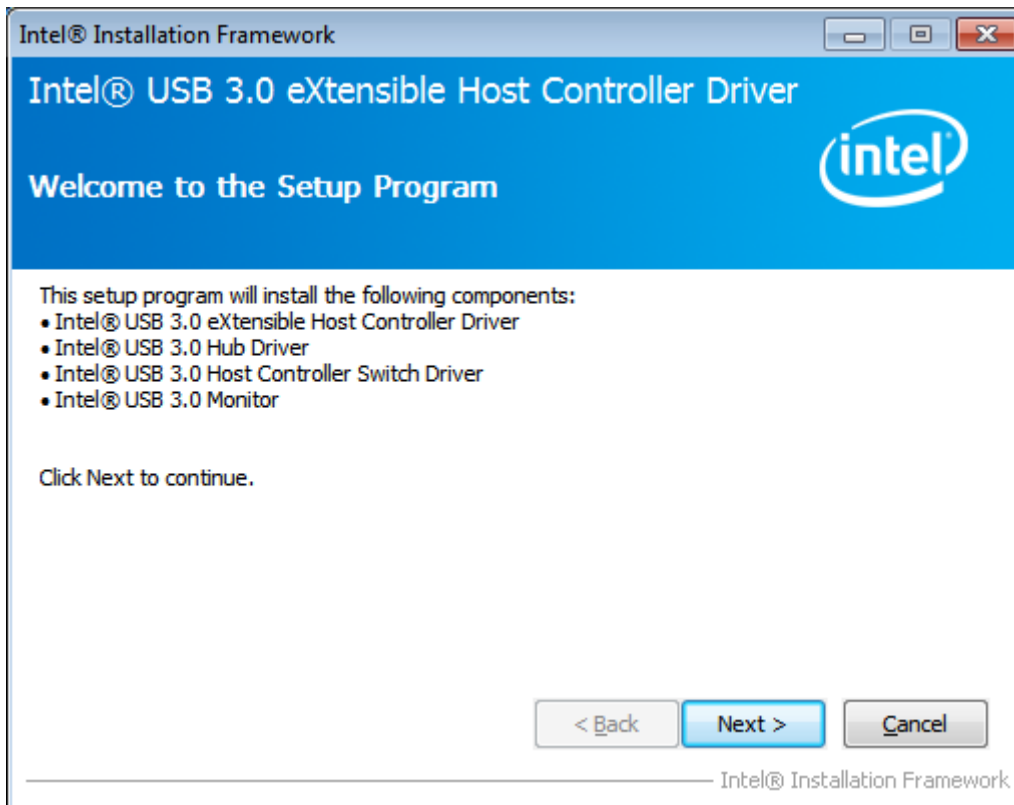

Step 3. Read the license agreement. Then click **Yes** to continue.

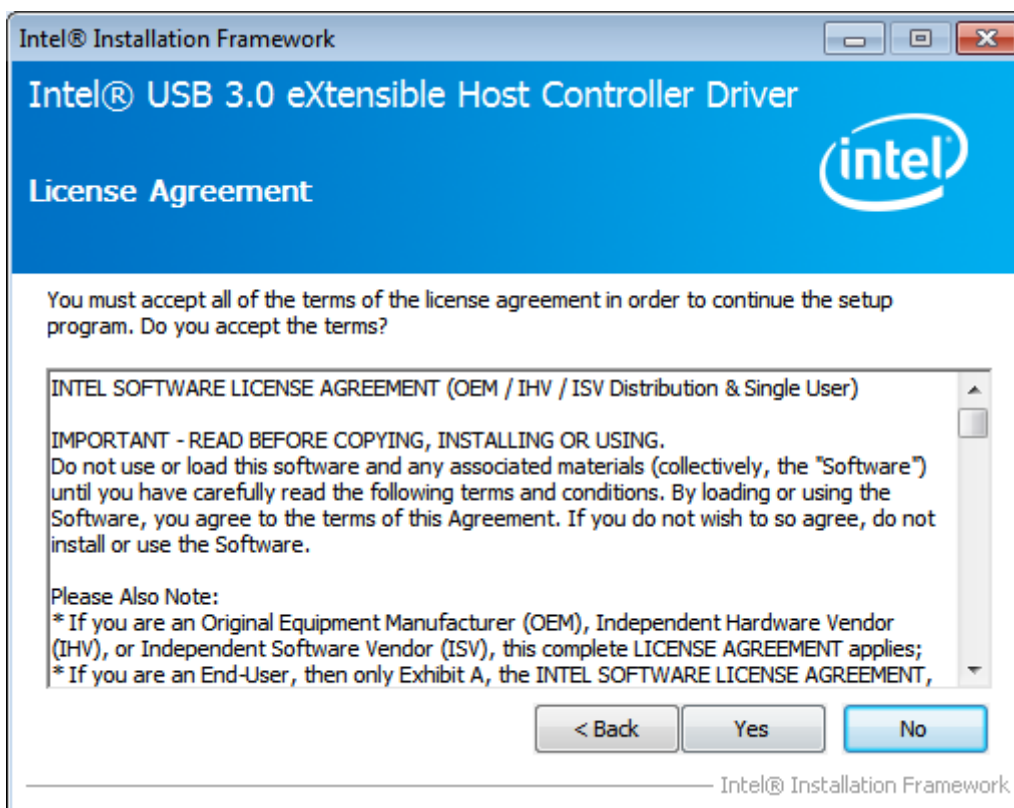

Step 4. Click **Next** to continue.

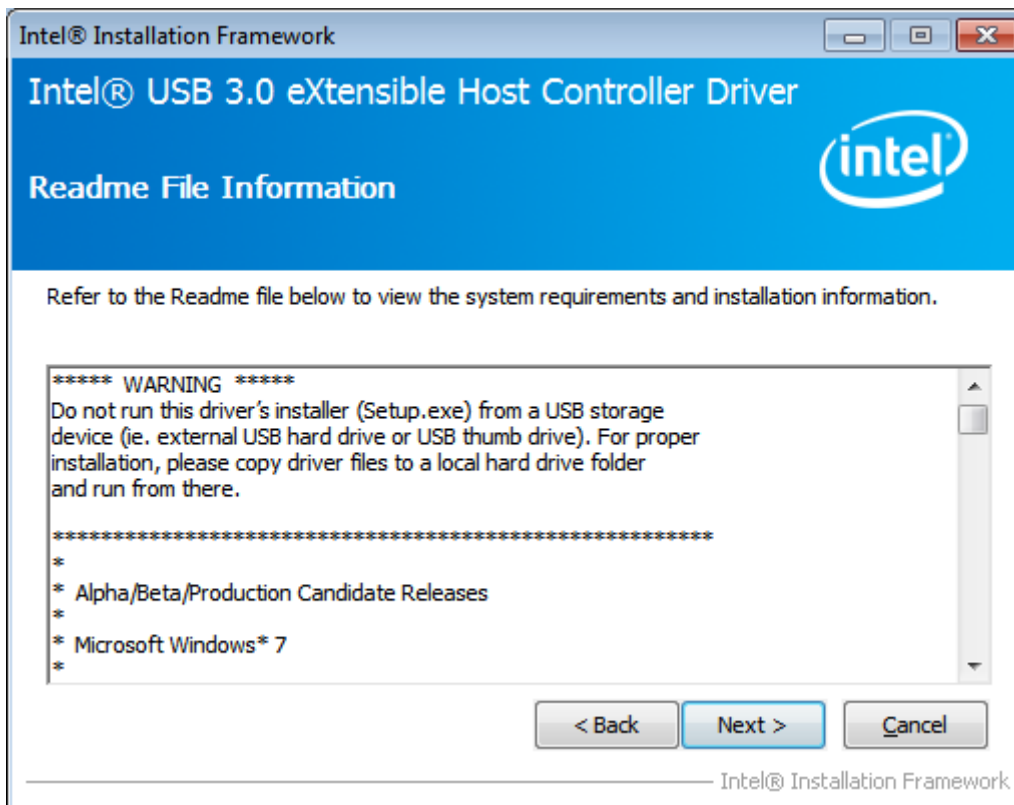

Step 5. Click **Next** to continue.

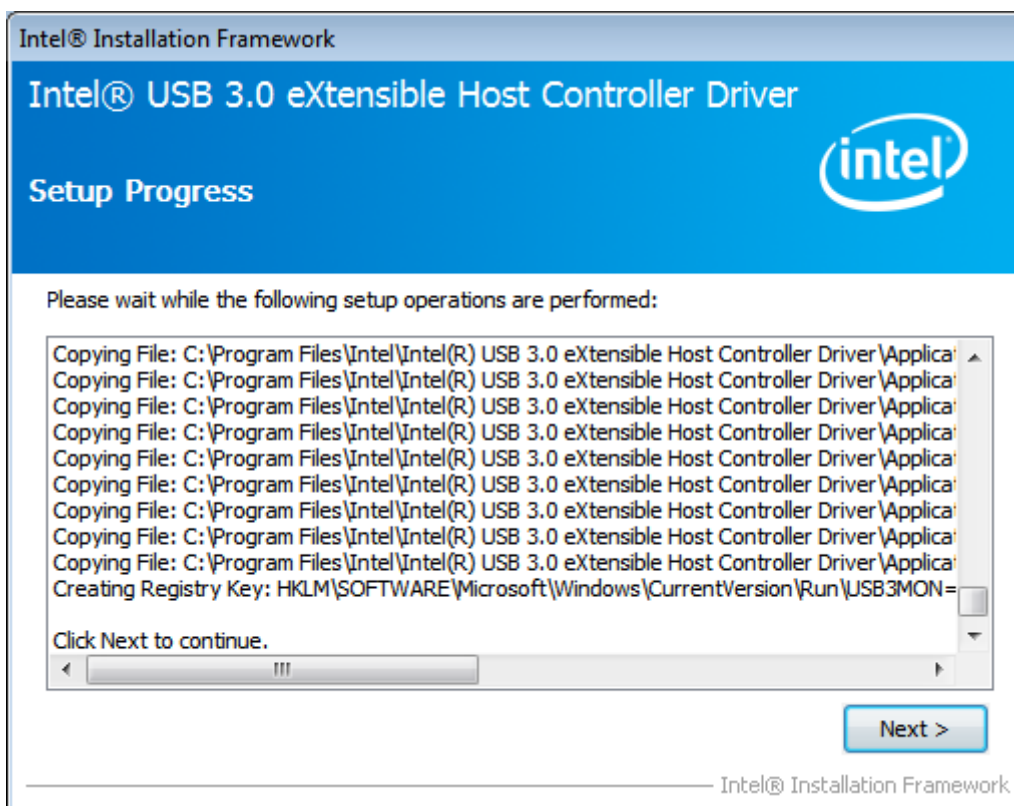

Step 6. Select **Yes, I want to restart this computer now.** Then click **Finish** to complete

the installation.

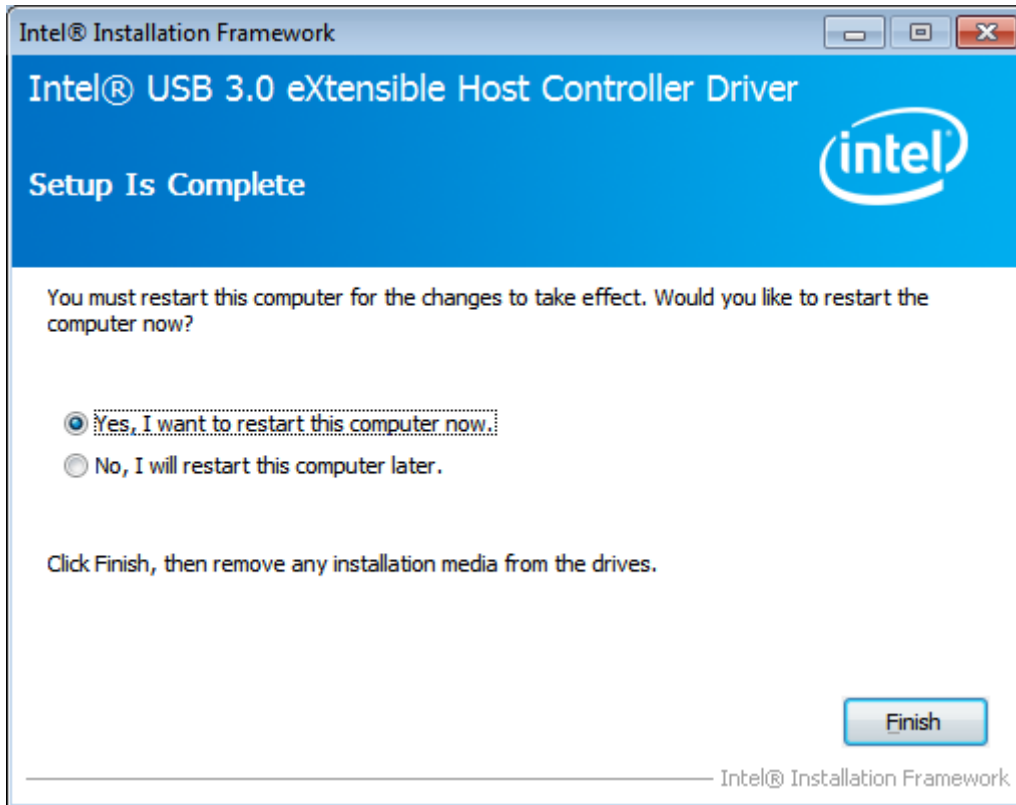

Chapter 5 Touch Screen Installation

This chapter describes how to install drivers and other software that will allow your touch screen work with different operating systems.

5.1 Windows XP/2003/Vista/WIN7 Universal Driver

Installation for PenMount 6000 Series

Before installing the Windows XP/2003/Vista/WIN7 driver software, you must have the Windows XP/2003/Vista/WIN7 system installed and running on your computer. You must also have one of the following PenMount 6000 series controller or control boards installed: PM6500, PM6300.

5.1.1 Installing Software(Resistive Touch)

If you have an older version of the PenMount Windows WIN7 driver installed in your system, please remove it first. Follow the steps below to install the PenMount DMC6000 Windows WIN7 driver.

Step 1. Insert the product CD, the screen below would appear. Click **Touch Panel**

Driver.



Step 2. Select Resistive Touch.



Step 3. Click **Next** to continue.

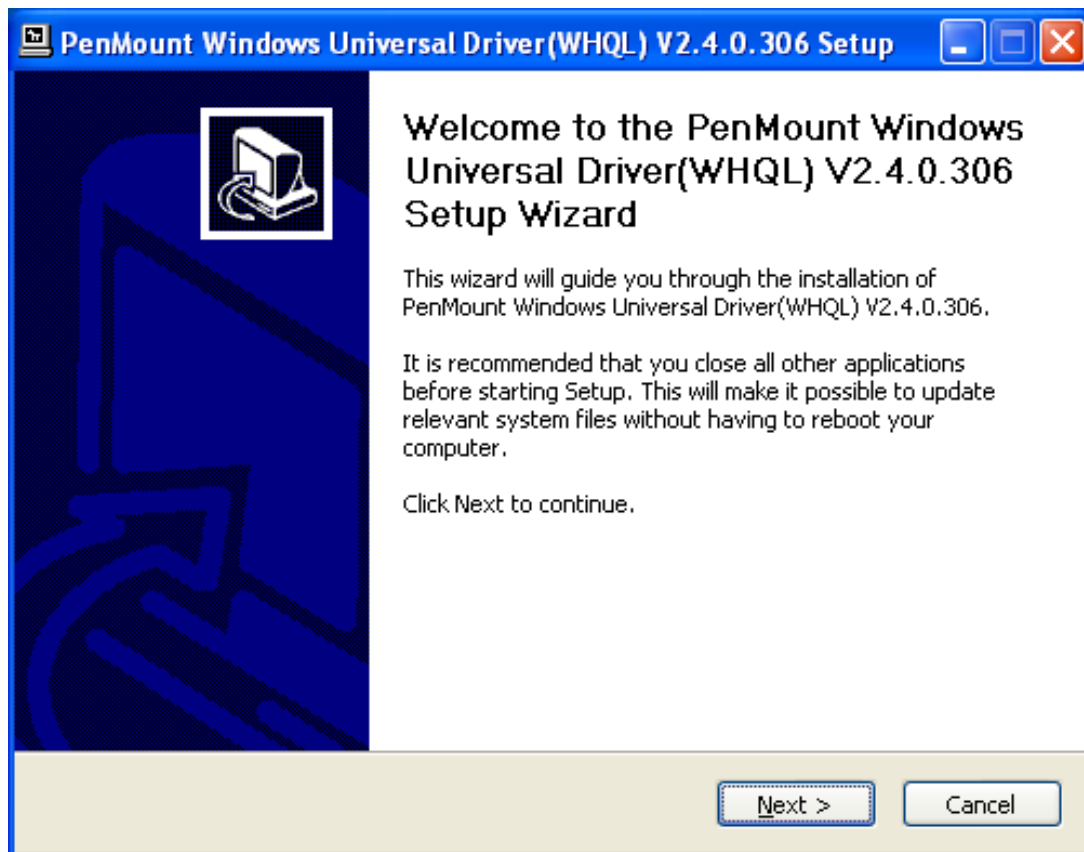

Step 4. Read the license agreement. Click **I Agree** to agree the license agreement.

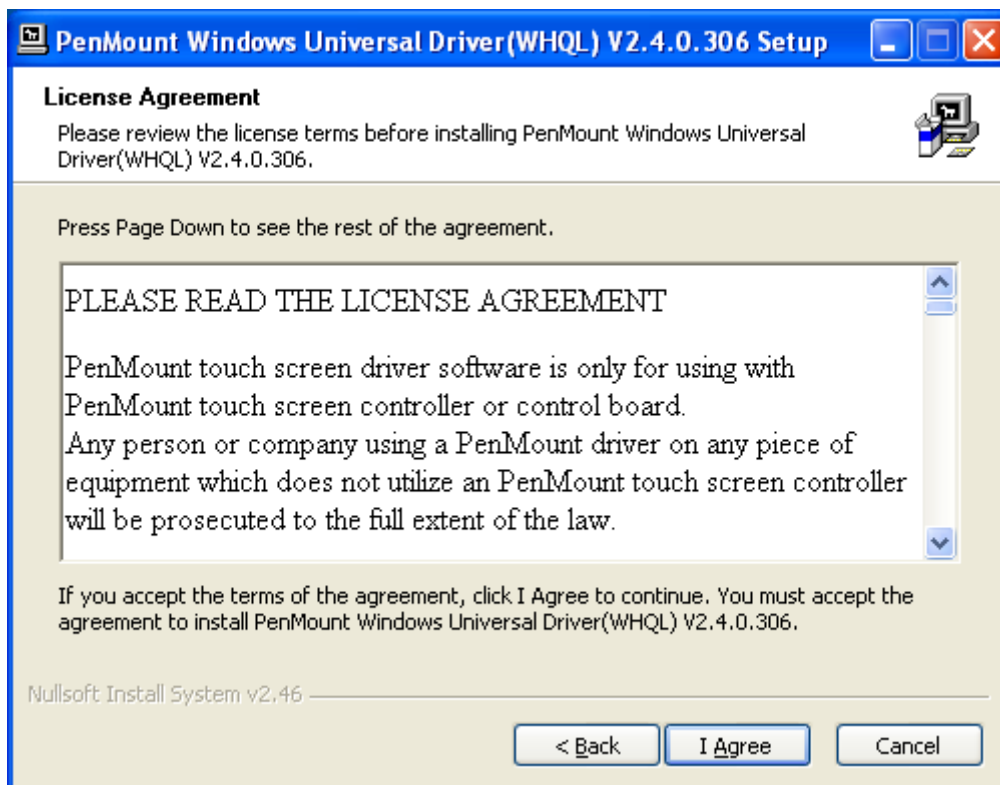

Step 5. Choose the folder in which to install PenMount Windows Universal Driver. Click **Install** to start the installation.

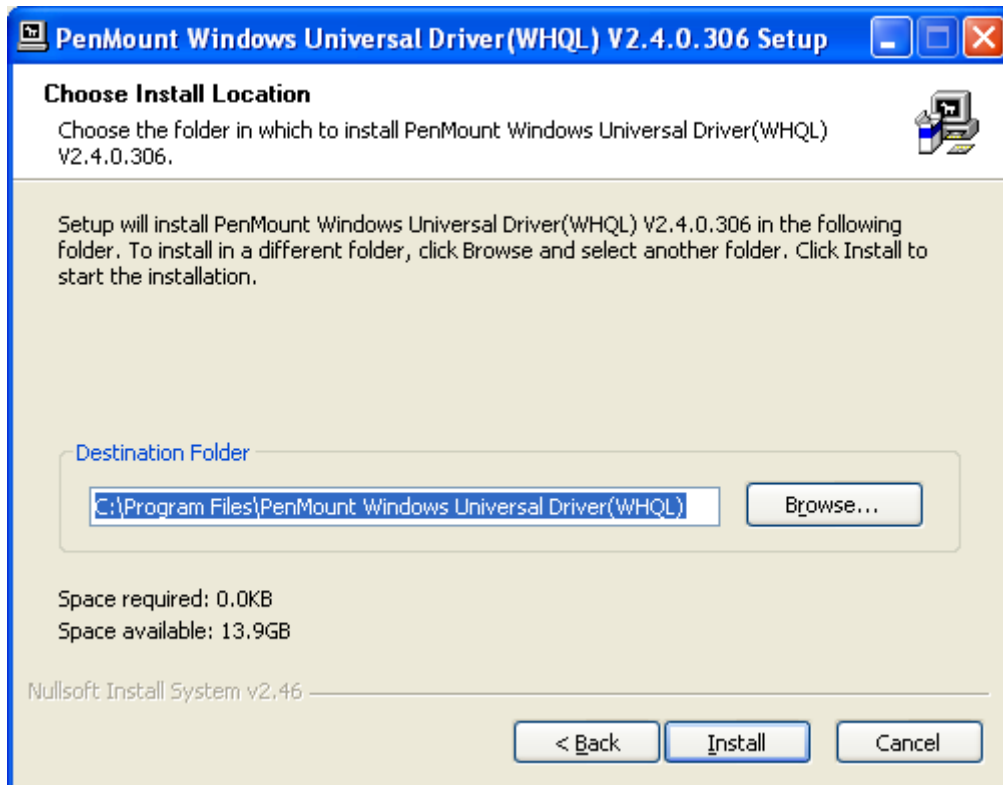

Step 6. Wait for installation. Then click **Next** to continue.

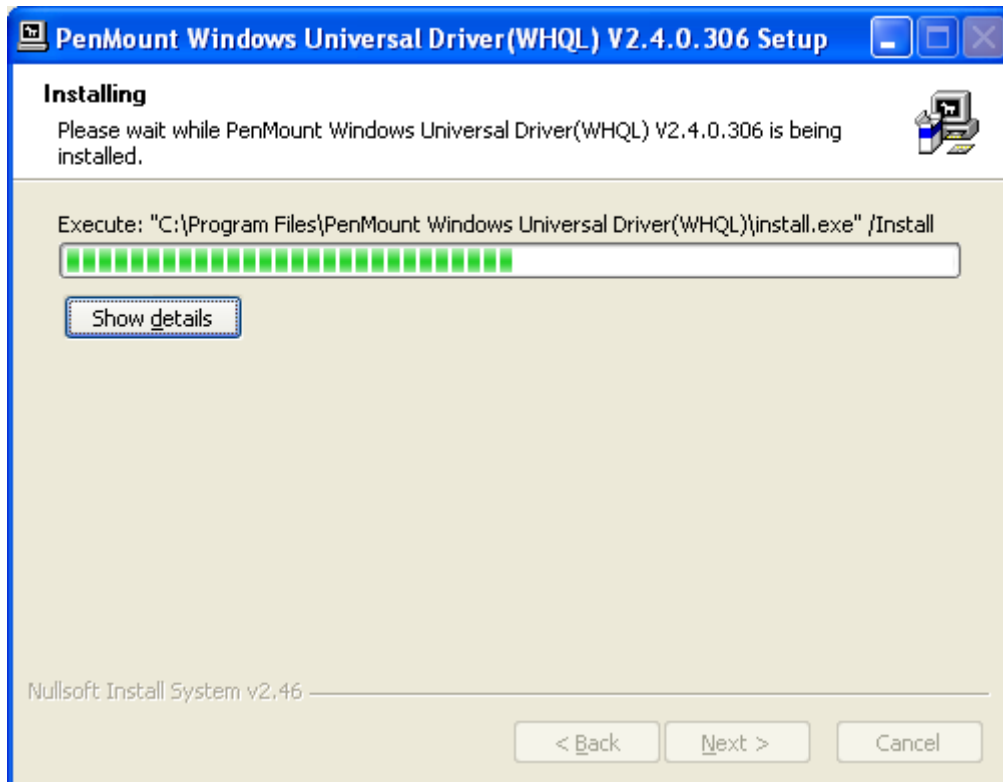

Step 7. Click Continue Anyway.



Step 8. Click Finish to complete installation.

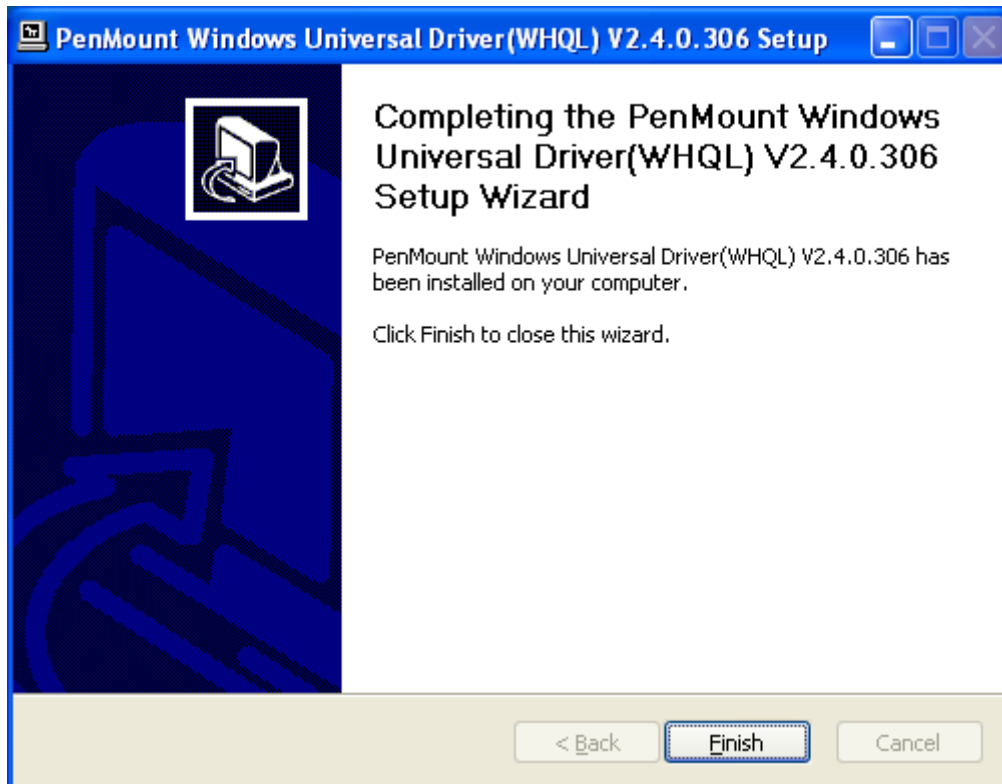

5.1.2 Installing Software (Projected Capacitive)

Step 1. Insert the product CD, the screen below would appear. Click touch panel driver.



Step 2. Select Projected Capacitive.



Step 3. Click **Next** to continue.

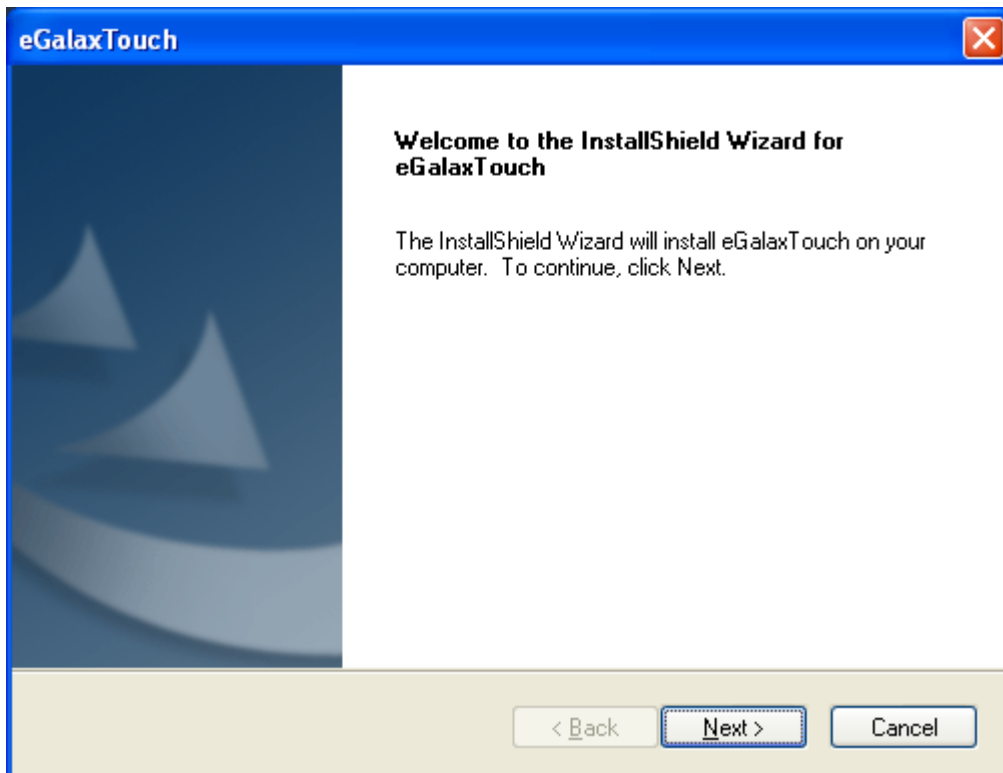

Step 4. Select **I accept the terms of the license agreement**. Click **Next**.

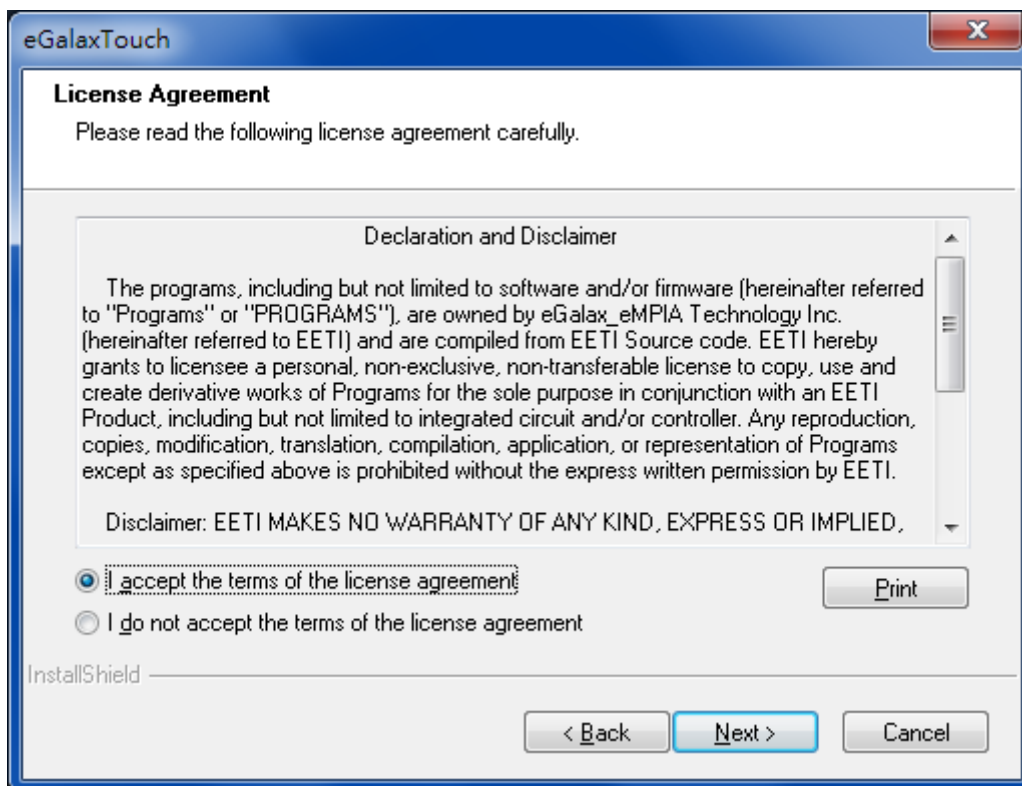

Step 5. Click Install RS232 interface driver.

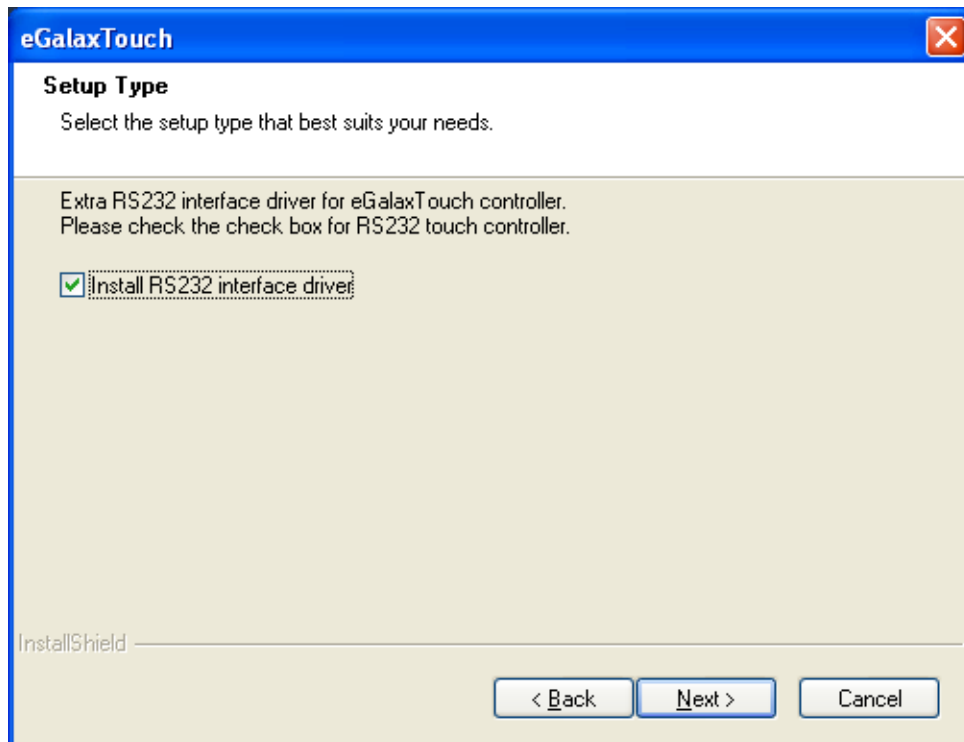

Step 6. Select None. Click Next.

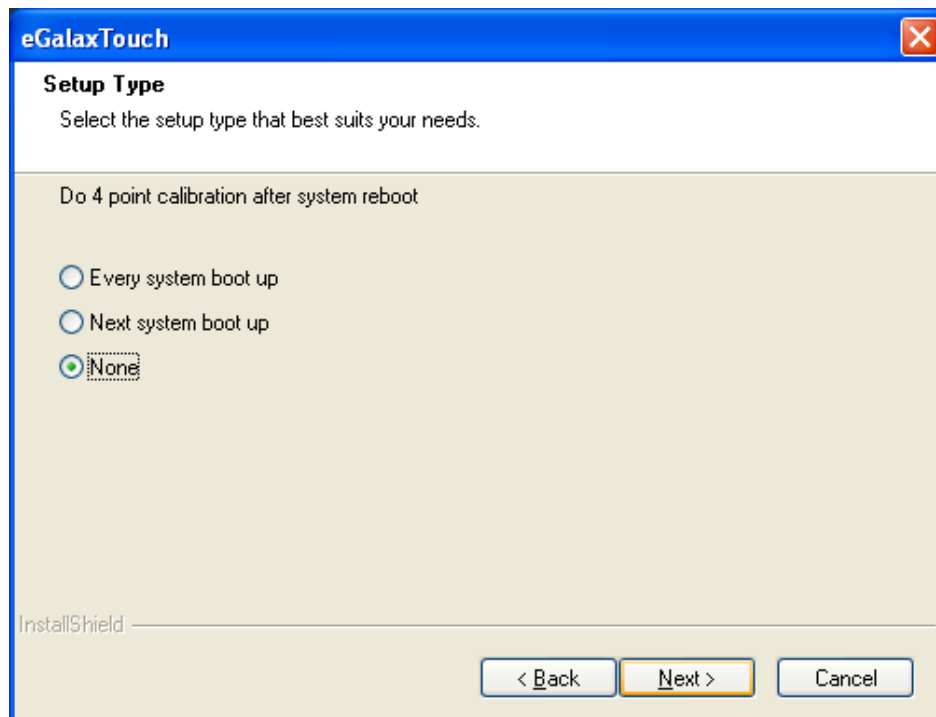

Step 7. Click OK.

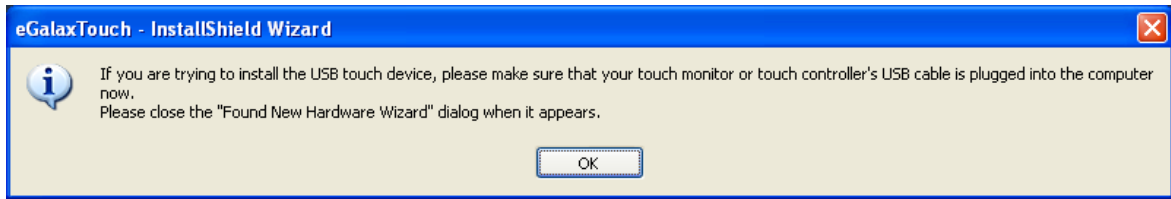

Step 8. Click Support Multi-Monitor System. Click Next.

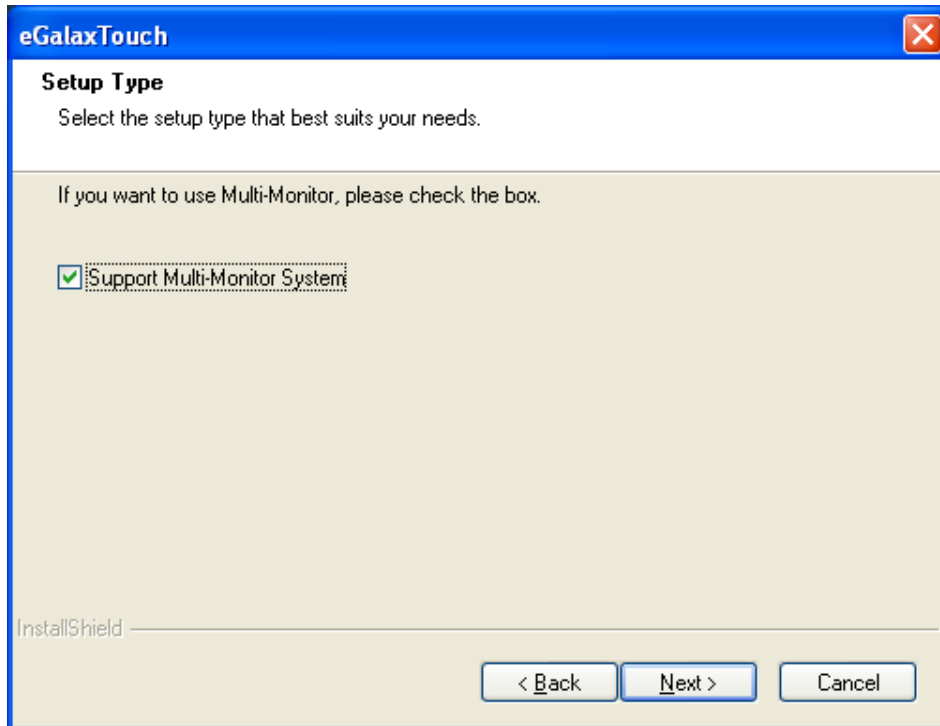

Step 9. Go to C:\Program Files\eGalaxTouch. Click Next.

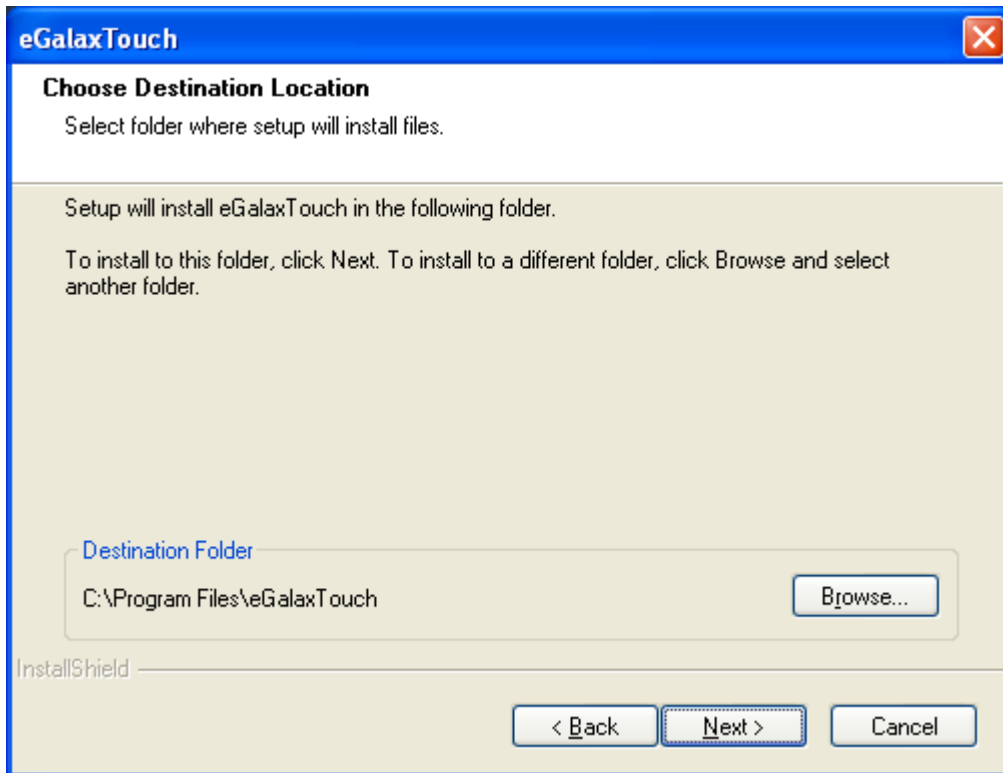

Step 10. Click **Next**.

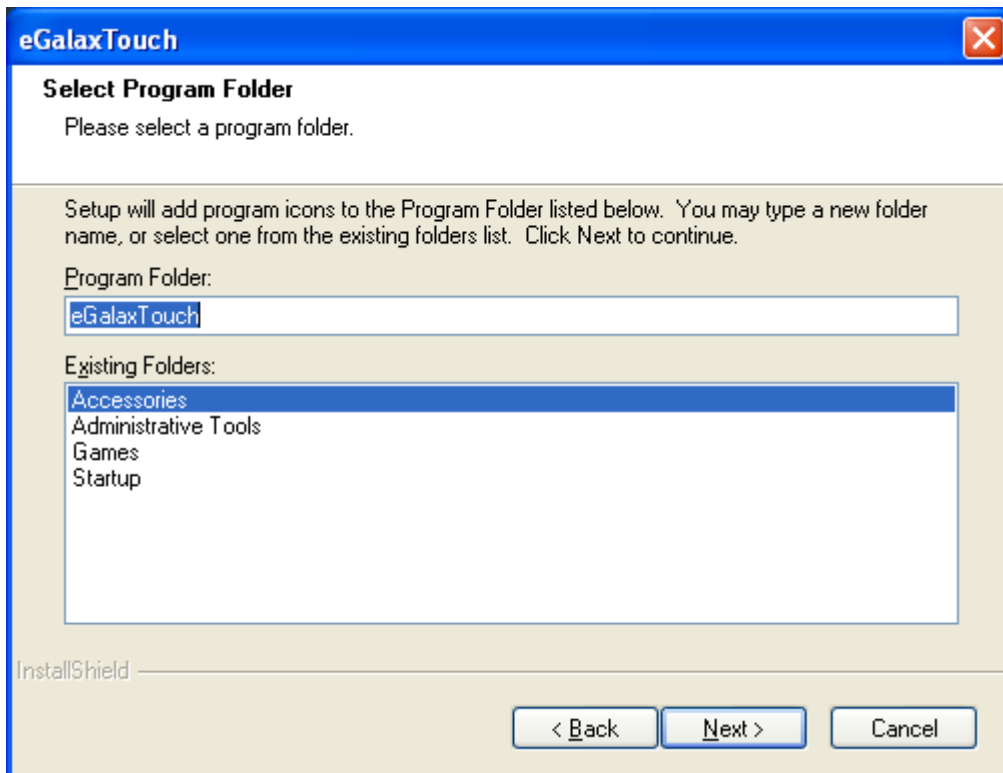

Step 11. Click **Create a eGalaxTouch Utility shortcut on desktop**. Click **Next**.

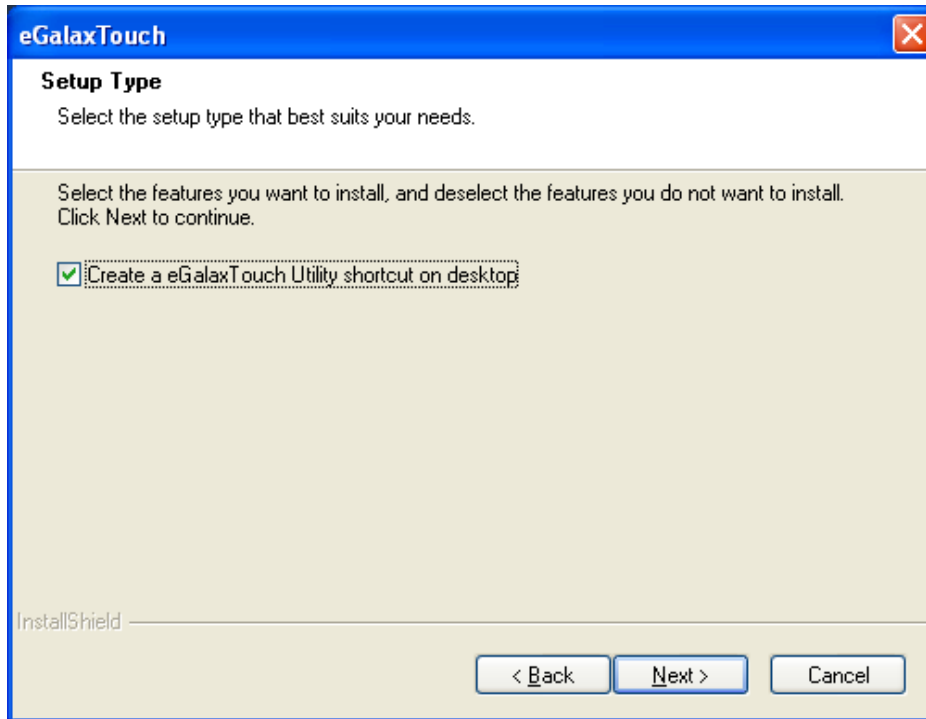

Step 12. Wait for installation.

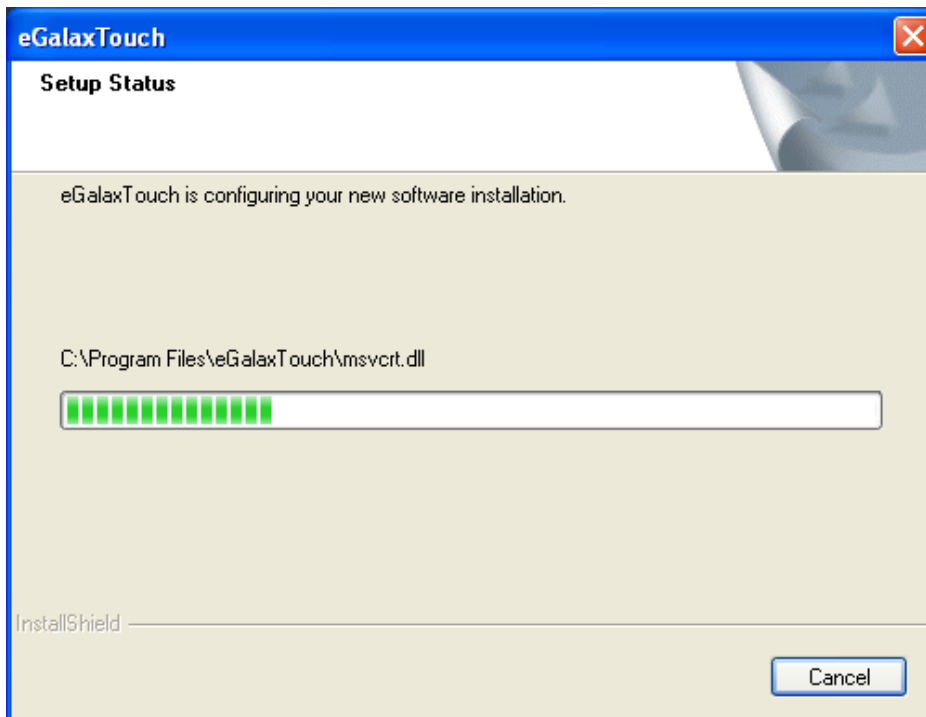

Step 13. Click **Yes** to do 4 point calibration.

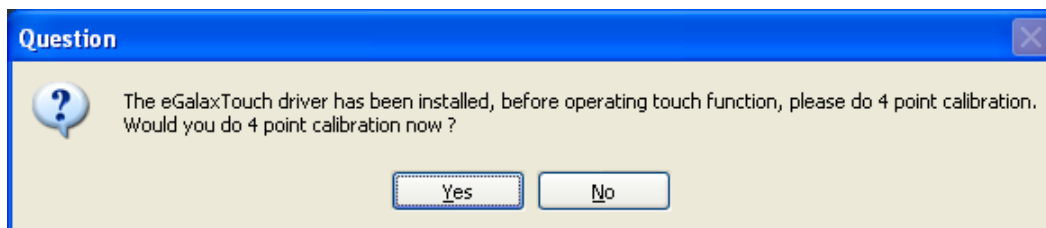

5.2 Software Functions

5.2.1 Software Functions(Resistive Touch)

Upon rebooting, the computer automatically finds the new 6000 controller board. The touch screen is connected but not calibrated. Follow the procedures below to carry out calibration.

1. After installation, click the PenMount Monitor icon “PM” in the menu bar.
2. When the PenMount Control Panel appears, select a device to “Calibrate.”

PenMount Control Panel(Resistive Touch)

The functions of the PenMount Control Panel are **Device**, **Multiple Monitors**, **Tools** and **About**, which are explained in the following sections.

Device

In this window, you can find out that how many devices be detected on your system.

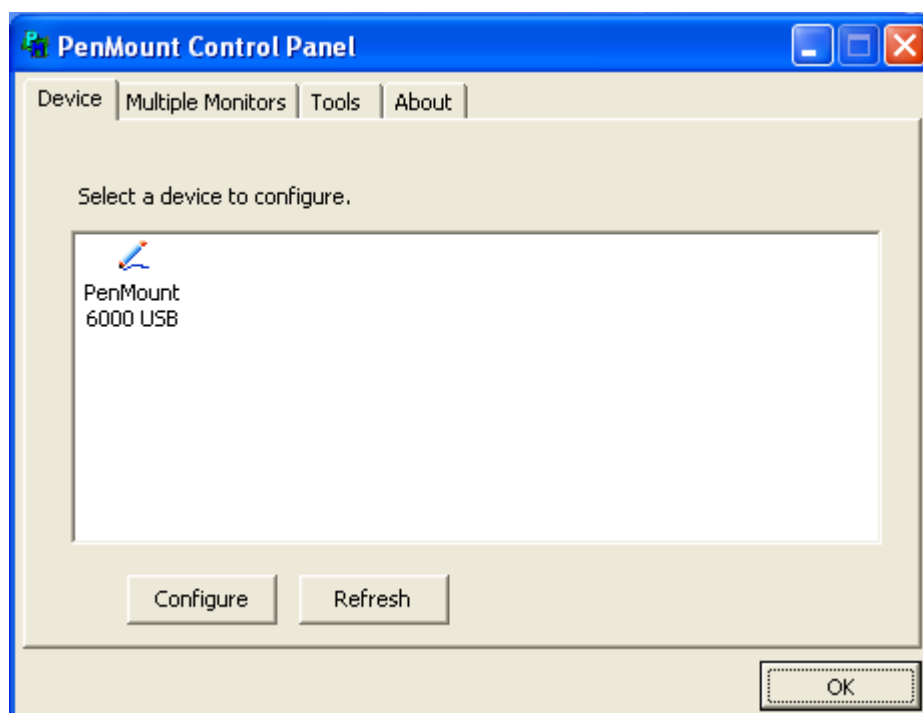

Calibrate

This function offers two ways to calibrate your touch screen. ‘Standard Calibration’ adjusts most touch screens. ‘Advanced Calibration’ adjusts aging touch screens.

Standard Calibration	Click this button and arrows appear pointing to red squares. Use your finger or stylus to touch the red squares in sequence. After the fifth red point calibration is complete. To skip, press 'ESC'.
Advanced Calibration	Advanced Calibration uses 4, 9, 16 or 25 points to effectively calibrate touch panel linearity of aged touch screens. Click this button and touch the red squares in sequence with a stylus. To skip, press ESC'.

Step 1. Please select a device then click “Configure”. You can also double click the device too.

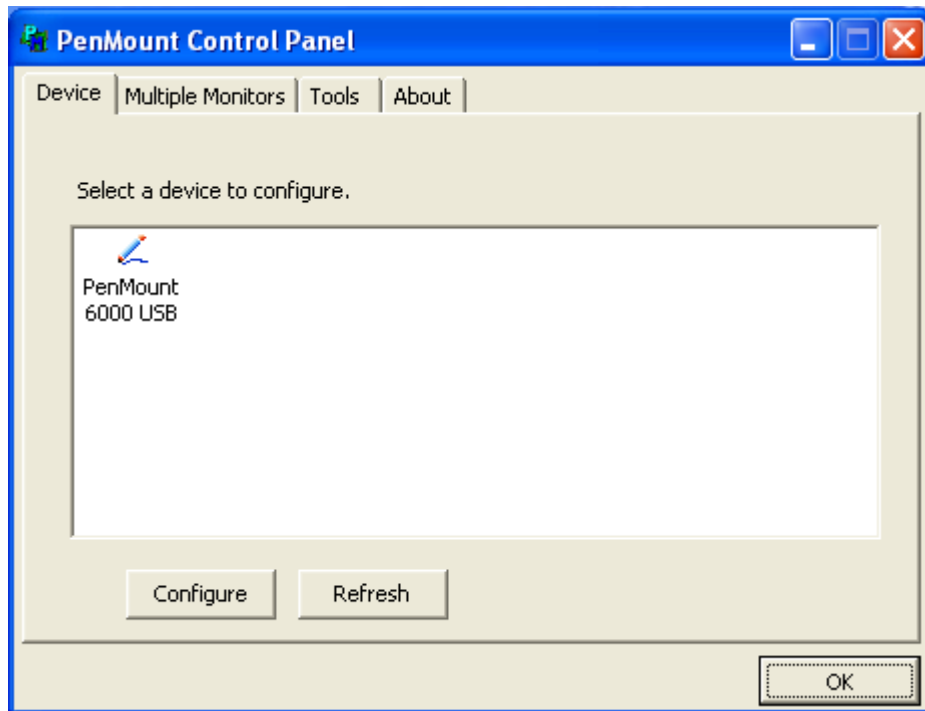

Step 2. Click “**Standard Calibration**” to start calibration procedure

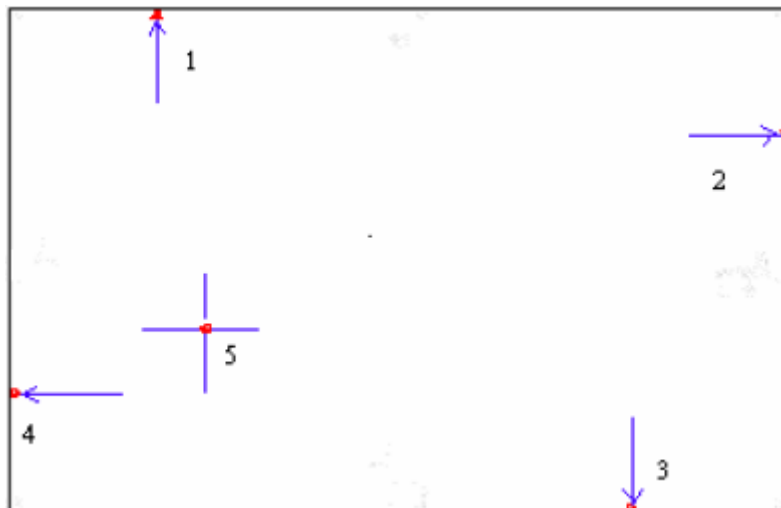

NOTE: The older the touch screen, the more Advanced Mode calibration points you need for an accurate calibration. Use a stylus during Advanced Calibration for greater accuracy. Please follow the step as below:

Step 3. Come back to “PenMount Control Panel” and select **Tools** then click **Advanced Calibration**.

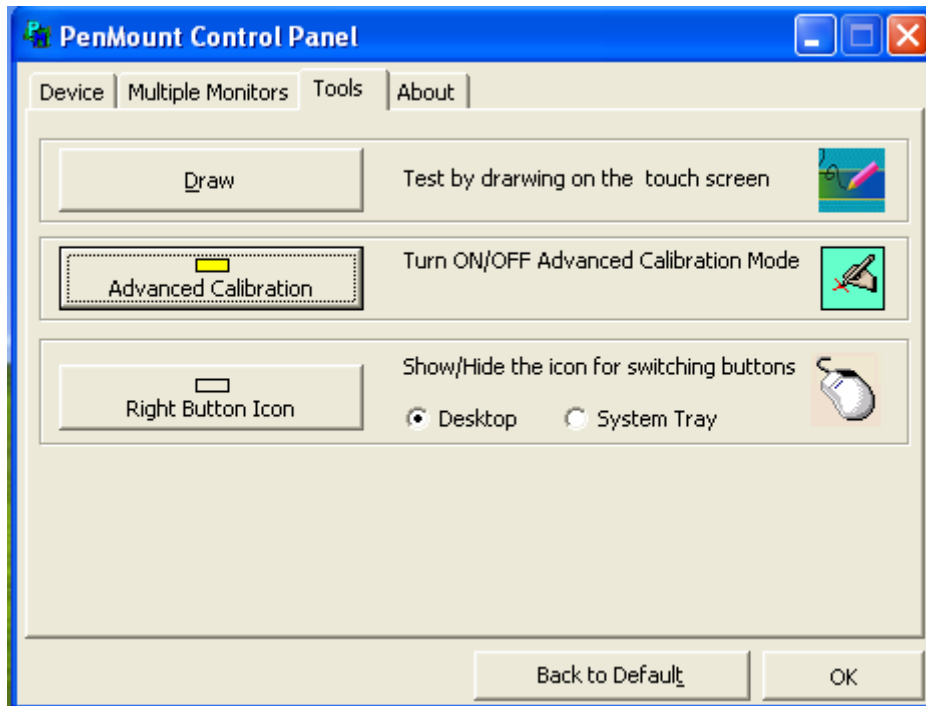

Step 4. Select **Device** to calibrate, then you can start to do **Advanced Calibration**.



NOTE: Recommend to use a stylus during Advanced Calibration for greater accuracy.

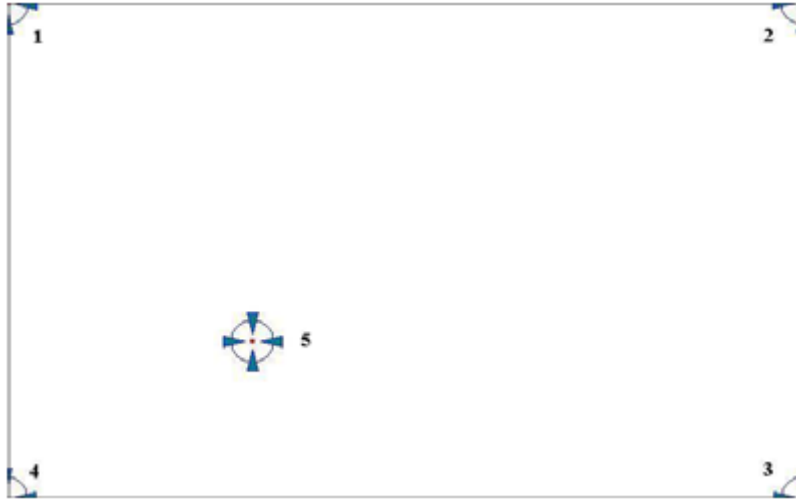

Plot Calibration Data	Check this function and a touch panel linearity comparison graph appears when you have finished Advanced Calibration. The blue lines show linearity before calibration and black lines show linearity after calibration.
Turn off EEPROM storage	The function disable for calibration data to write in Controller. The default setting is Enable.

Setting

Touch Mode	This mode enables and disables the mouse's ability to drag on-screen icons – useful for configuring POS terminals. Mouse Emulation – Select this mode and the mouse functions as normal and allows dragging of icons. Click on Touch – Select this mode and mouse only provides a click function, and dragging is disables.
Beep Sound	Enable Beep Sound – turns beep function on and off Beep on Pen Down – beep occurs when pen comes down Beep on Pen Up – beep occurs when pen is lifted up Beep on both – beep occurs when comes down and lifted up Beep Frequency – modifies sound frequency Beep Duration – modifies sound duration
Cursor Stabilizer	Enable the function support to prevent cursor shake.
Use press and hold as right click	You can set the time out and area for you need.

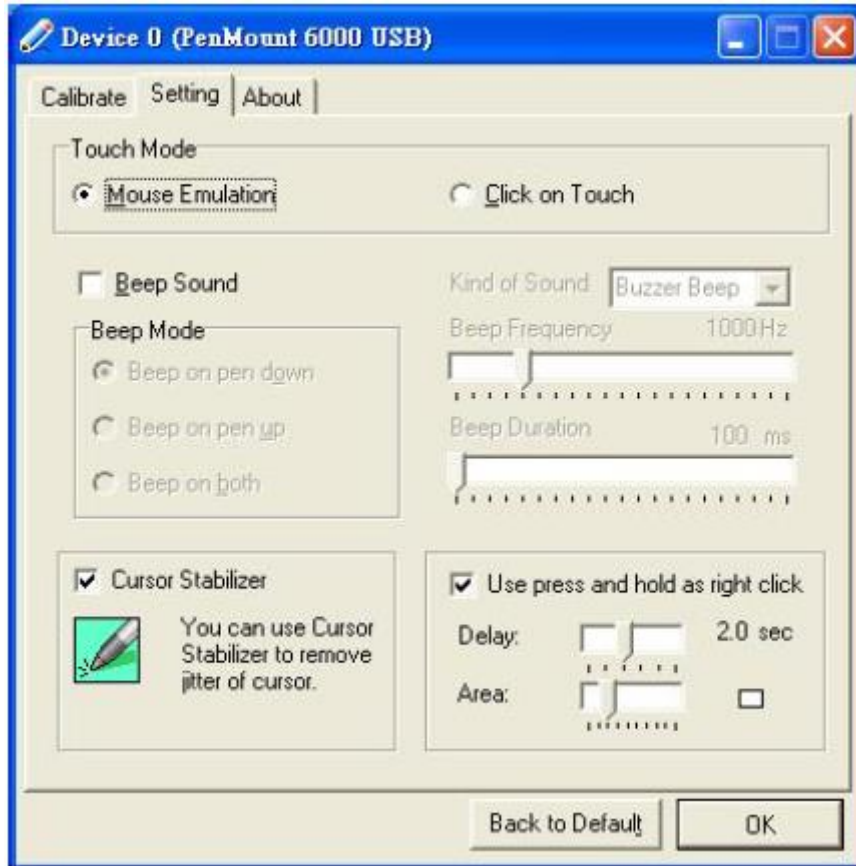

About

This panel displays information about the PenMount controller and driver version.

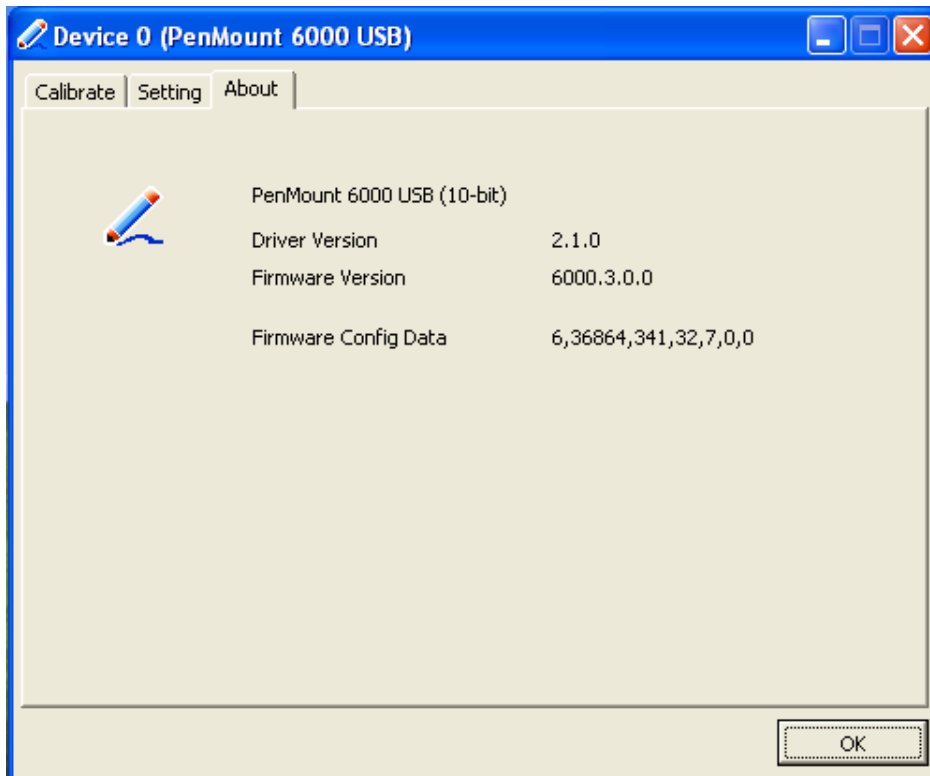

Multiple Monitors

Multiple Monitors support from two to six touch screen displays for one system. The PenMount drivers for Windows XP/2003/Vista/WIN7 support Multiple Monitors. This function supports from two to six touch screen displays for one system. Each monitor requires its own PenMount touch screen control board, either installed inside the display or in a central unit. The PenMount control boards must be connected to the computer COM ports via the USB interface. Driver installation procedures are the same as for a single monitor. Multiple Monitors support the following modes:

- Windows Extends Monitor Function
- Matrox DualHead Multi-Screen Function
- nVidia nView Function

NOTE: The Multiple Monitor function is for use with multiple displays only. Do not use this function if you have only one touch screen display. Please note once you turn on this function the rotating function is disabled.

Enable the multiple display function as follows:

1. Check the **Enable Multiple Monitor Support** box; then click **Map Touch Screens** to assign touch controllers to displays.

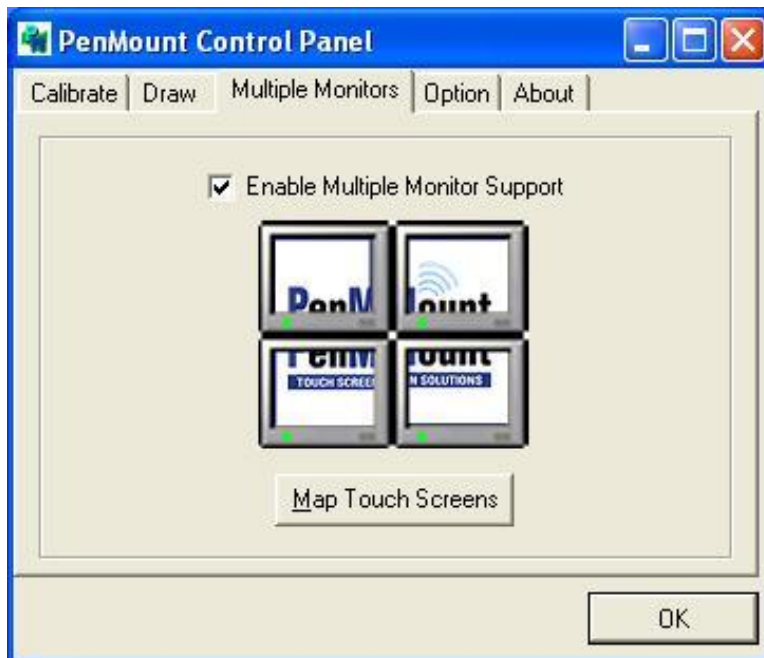

2. When the mapping screen message appears, click **OK**.

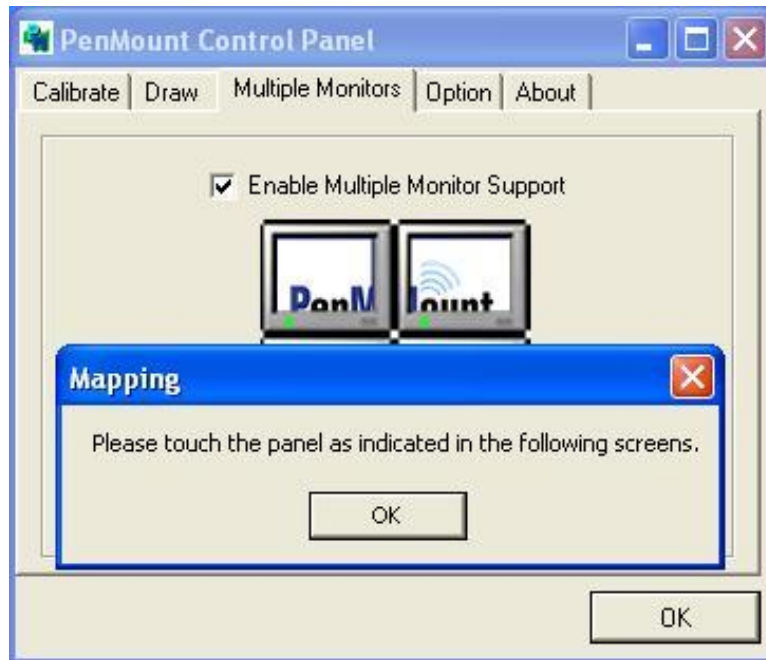

3. Touch each screen as it displays “Please touch this monitor”. Following this sequence and touching each screen is called **mapping the touch screens**.

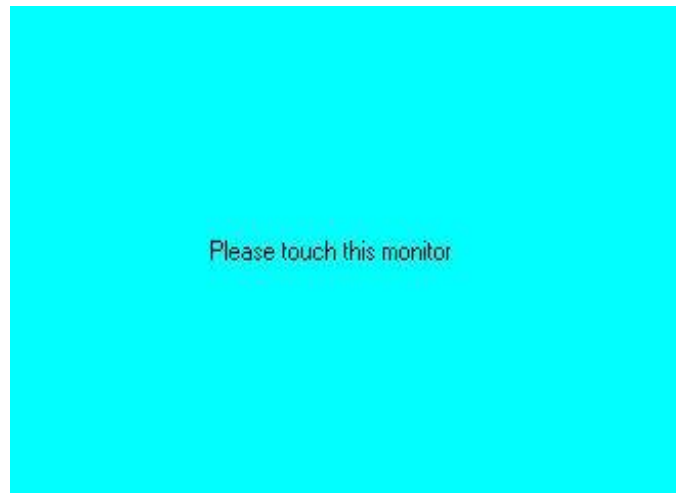

4. Touching all screens completes the mapping and the desktop reappears on the monitors.
5. Select a display and execute the “Calibration” function. A message to start calibration appears. Click **OK**.

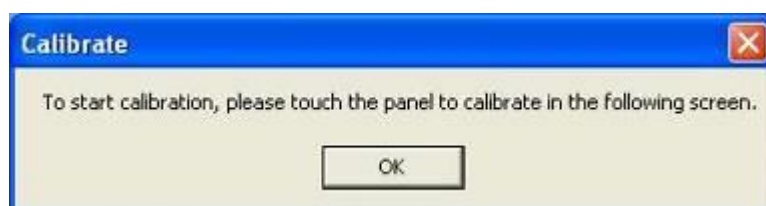

6. "Touch this screen to start its calibration" appears on one of the screens. Touch the screen.
7. "Touch the red square" messages appear. Touch the red squares in sequence.
8. Continue calibration for each monitor by clicking **Standard Calibration** and touching the red squares.

NOTES:

1. If you use a single VGA output for multiple monitors, please do not use the **Multiple Monitor** function. Just follow the regular procedure for calibration on each of your desktop monitors.
2. The Rotating function is disabled if you use the Multiple Monitor function.
3. If you change the resolution of display or screen address, you have to redo **Map Touch Screens**, so the system understands where the displays are.

About

This panel displays information about the PenMount controller and this driver version.

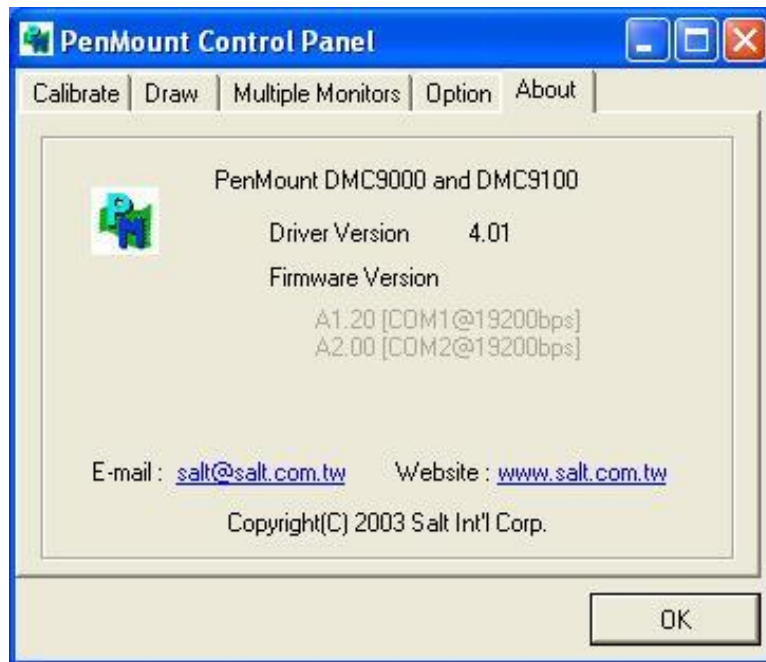

PenMount Monitor Menu Icon

The PenMount monitor icon (PM) appears in the menu bar of Windows XP/2003/Vista/WIN7 system when you turn on PenMount Monitor in PenMount Utilities.



PenMount Monitor has the following function



Control Panel	Open Control Panel Windows
Beep	Setting Beep function for each device
Right Button	When you select this function, a mouse icon appears in the right-bottom of the screen. Click this icon to switch between Right and Left Button functions. 
Exit	Exits the PenMount Monitor function.

Configuring the Rotate Function

1. Install the rotation software package.
2. Choose the rotate function (0°, 90°, 180°, 270°) in the 3rd party software. The calibration screen appears automatically. Touch this point and rotation is mapped.

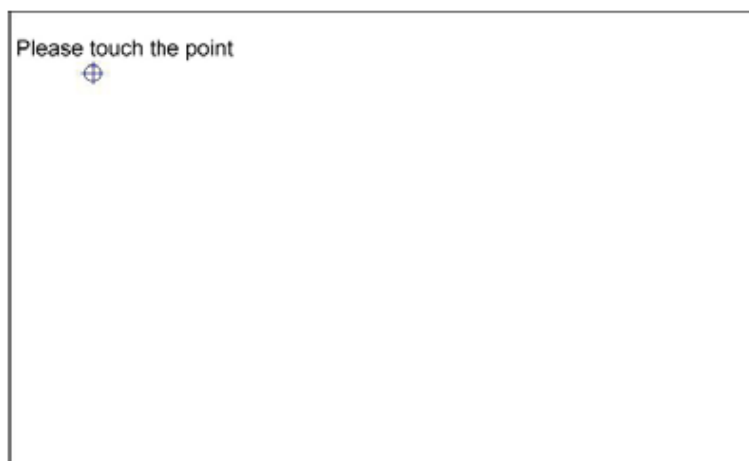

NOTE: The Rotate function is disabled if you use Monitor Mapping

5.2.2 Software Functions(Projected Capacitive)

General

In this window, you can see there is USB Controller. Click **OK** to continue.

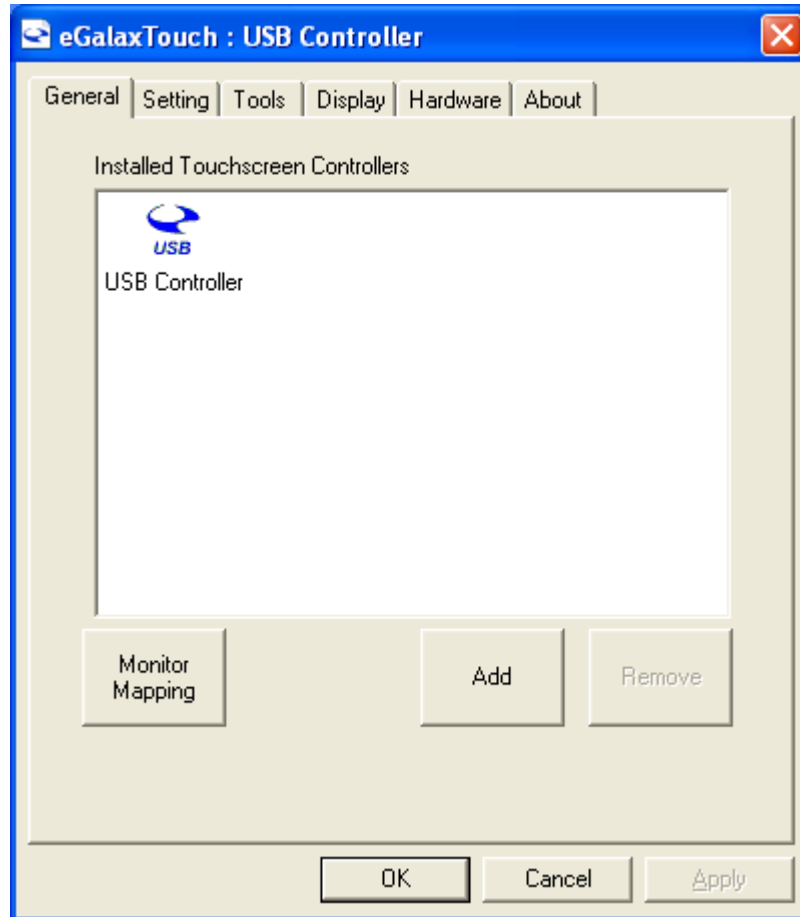

Monitor Mapping

to adjust touch panel

Add

to search for device

Setting

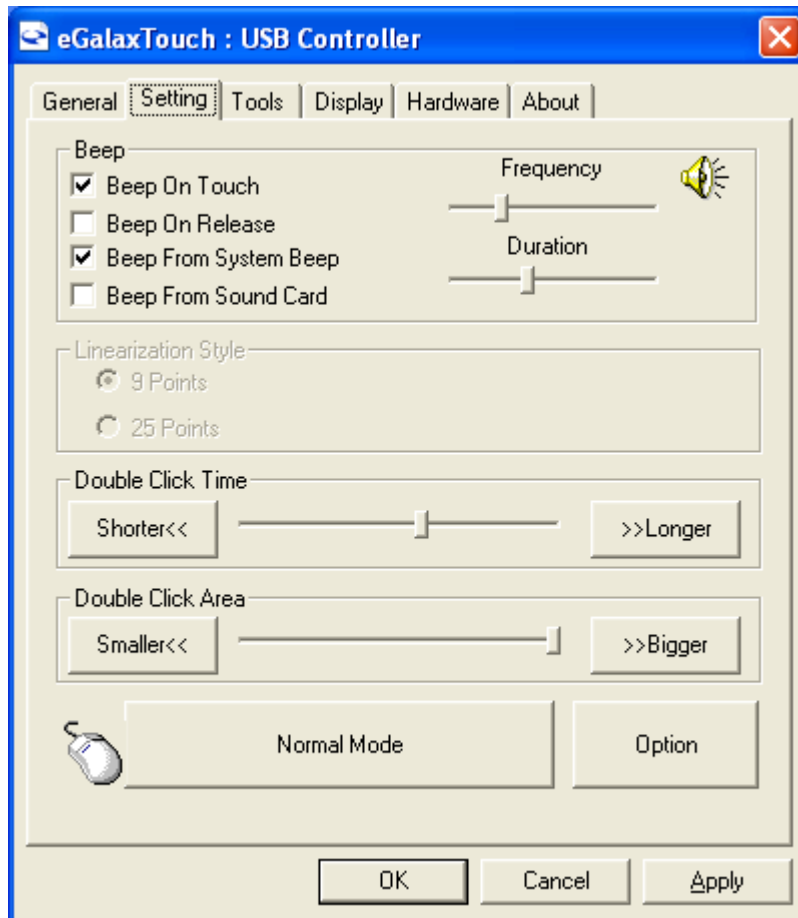

Beep

- Beep On Touch
- Beep On Release
- Beep From System Beep
- Beep From Sound Card

Linearization Style

- 9 points
- 25 points

Double Click Time

- Shorter
- Longer

Double Click Area

- Smaller
- Bigger

Normal mode

- Simulate the mouse mode

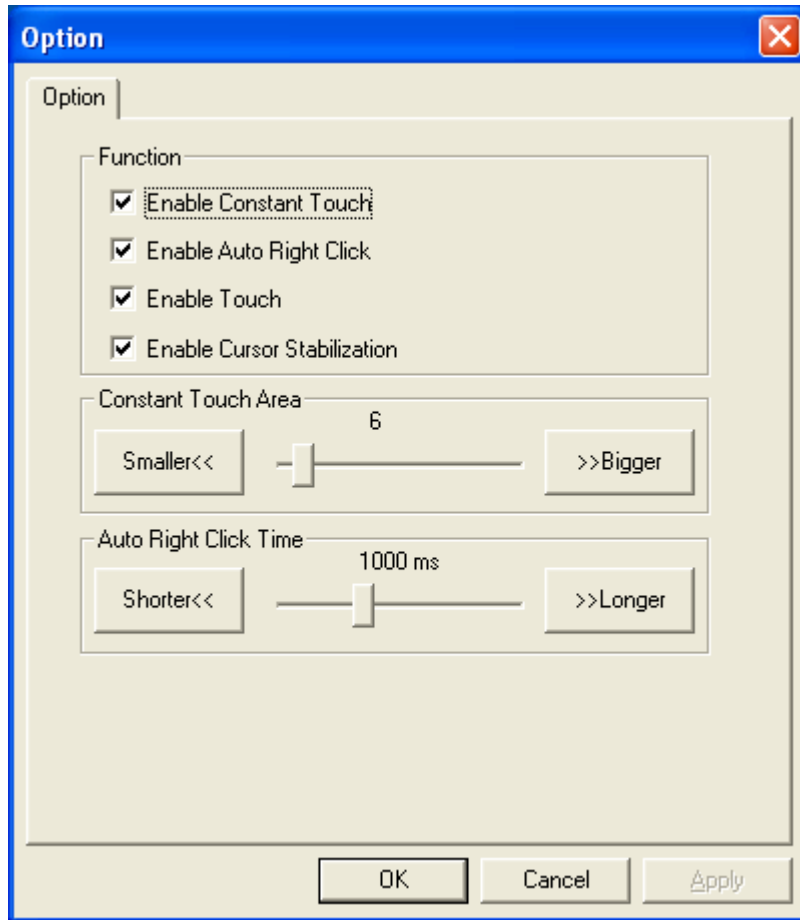

Option

Function

Enable Constant Touch

Enable Auto Right Click

Enable Touch

Enable Cursor Stabilization

Constant Touch Area

Auto Right Click Time

Tools

Click **OK** to continue the settings.

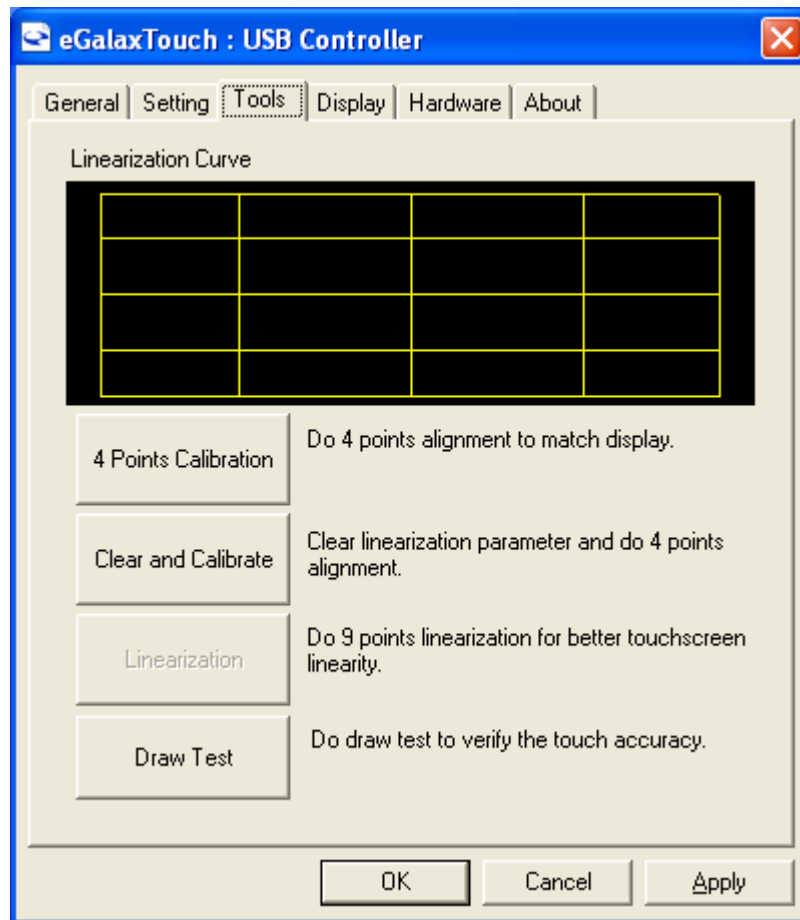

4 Points Calibration

Do 4 points alignment to match display.

Clear and Calibrate

Clear linearization parameter and do 4 points alignment.

Linearization

Do 9 points linearization for better touchscreen linearity.

Draw Test

Do draw test to verify the touch accuracy.

Display

In this window, it shows the mode of display.

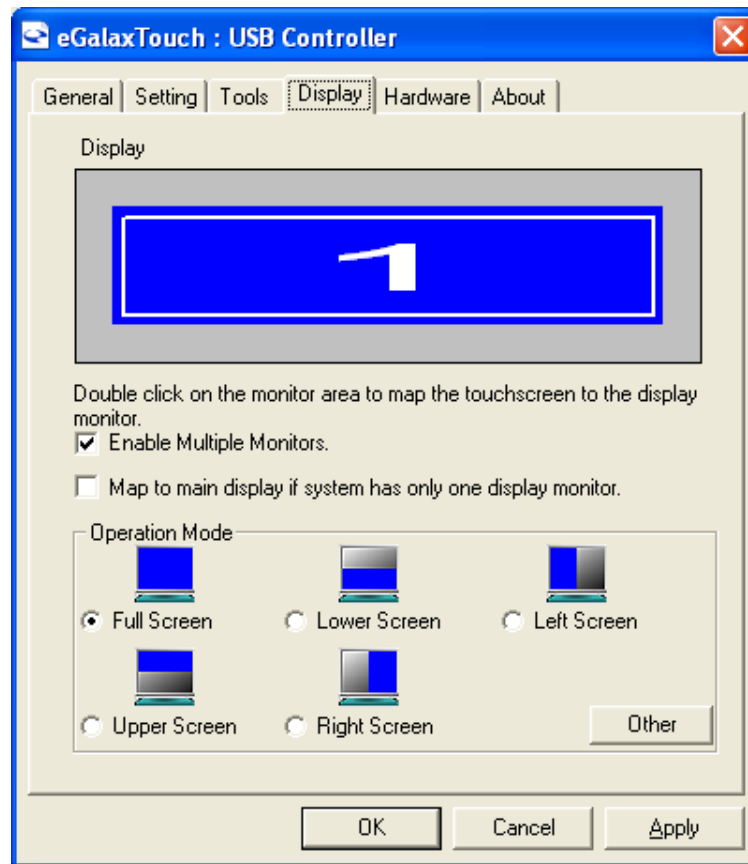

Enable Multiple Monitors.

Map to main display if system has only one display monitor

Full Screen

Lower Screen

Left Screen

Upper Screen

Right Screen

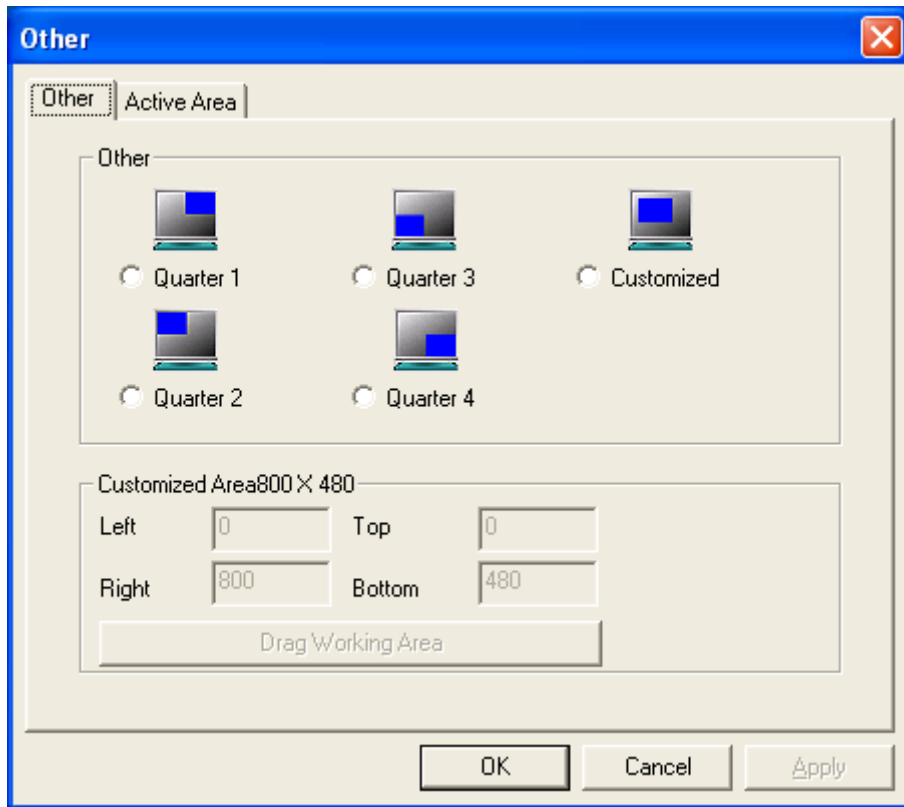

Other

Other mode of display. Quarter1~4 and Customized area.

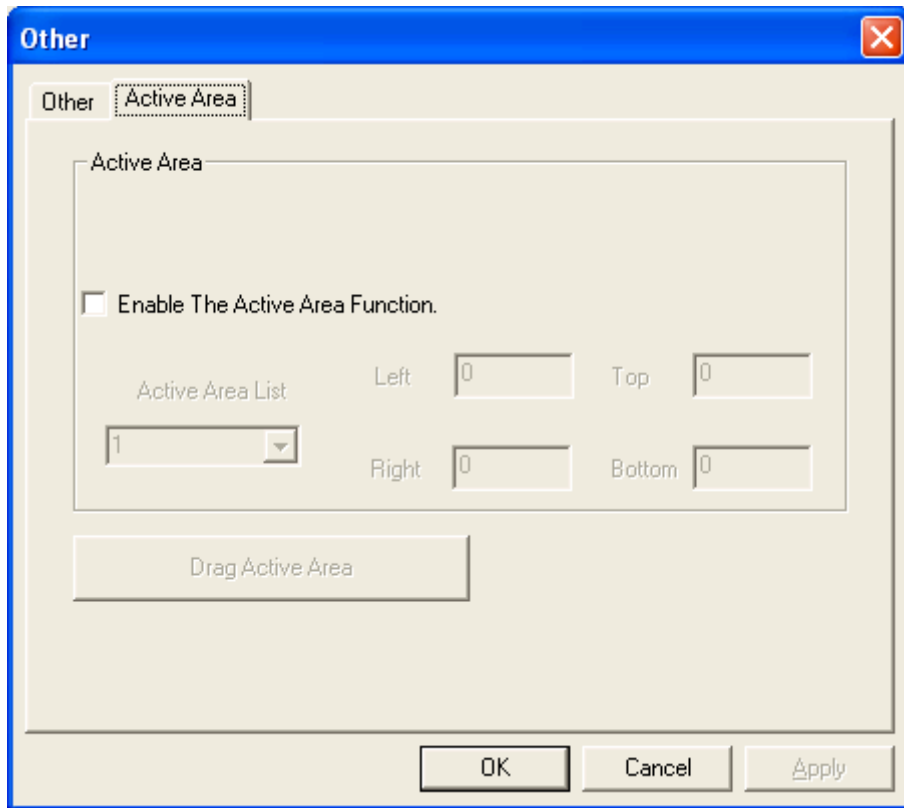

Active Area

Drag active area to enable Active Area Function.

Hardware

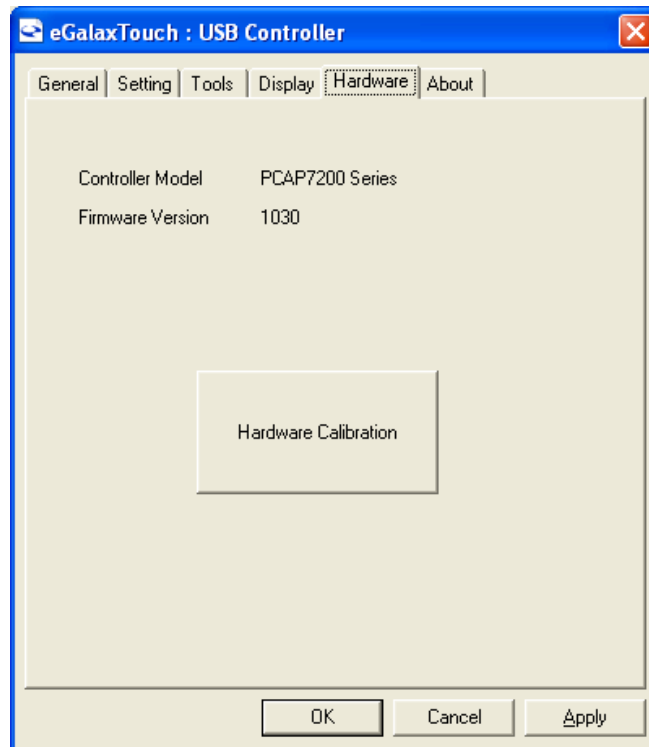

Saturn Hardware Configuration

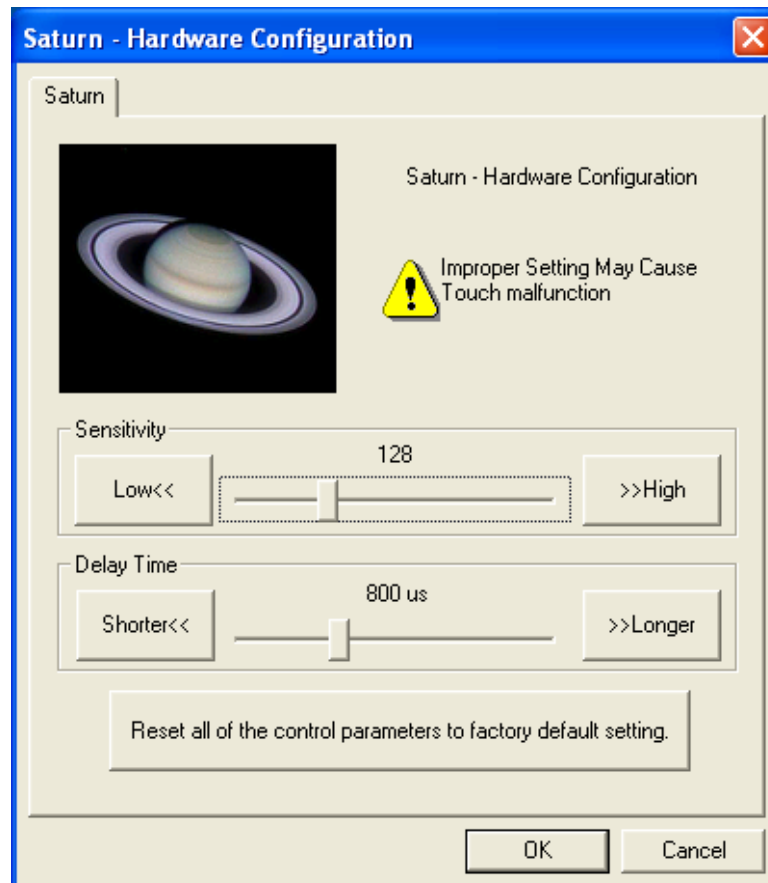

About

To display information about eGalaxTouch and its version.

